

KDC-X715

SERVICE MANUAL

© 2000-1 PRINTED IN JAPAN
B51-7569-00 (4) 1469

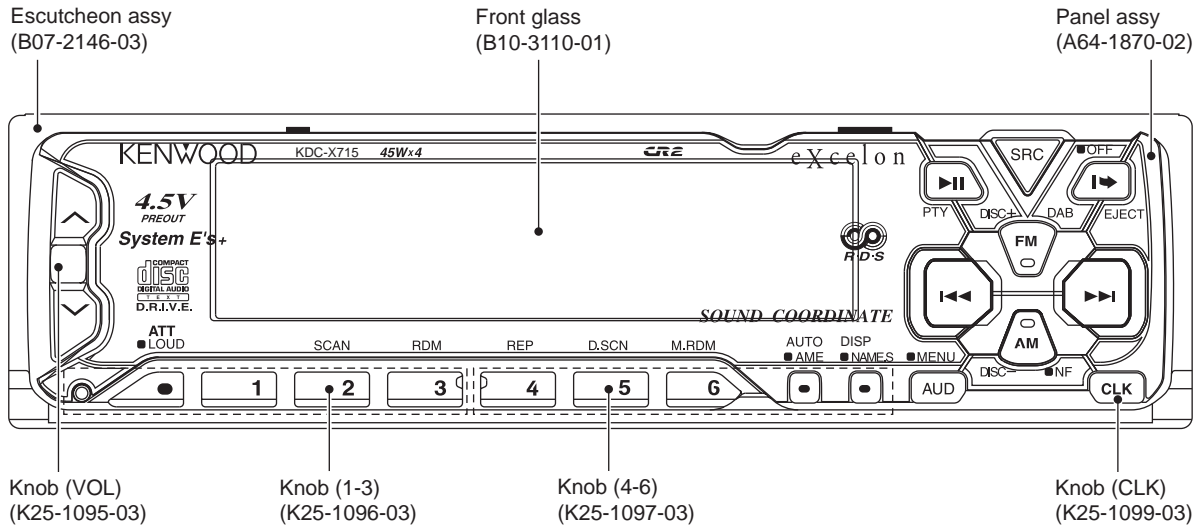

Extension cord	Parts No.
CD mechanism(22P)	W05-0618-00

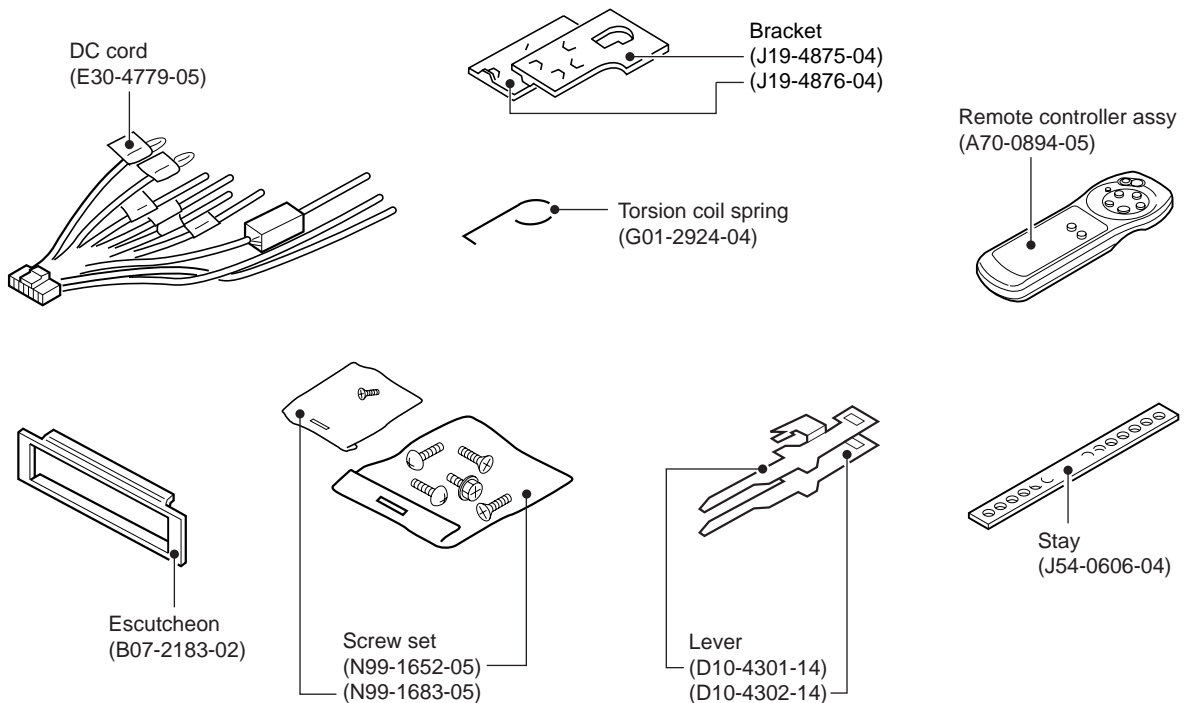

THE MECHANISM OPERATION DESCRIPTION is the same as model KDC-S3007 and KDC-5050RG. Please refer to the service manual for model KDC-S3007(B51-7029-00) or KDC-5050RG(B51-7099-00).



BLOCK DIAGRAM

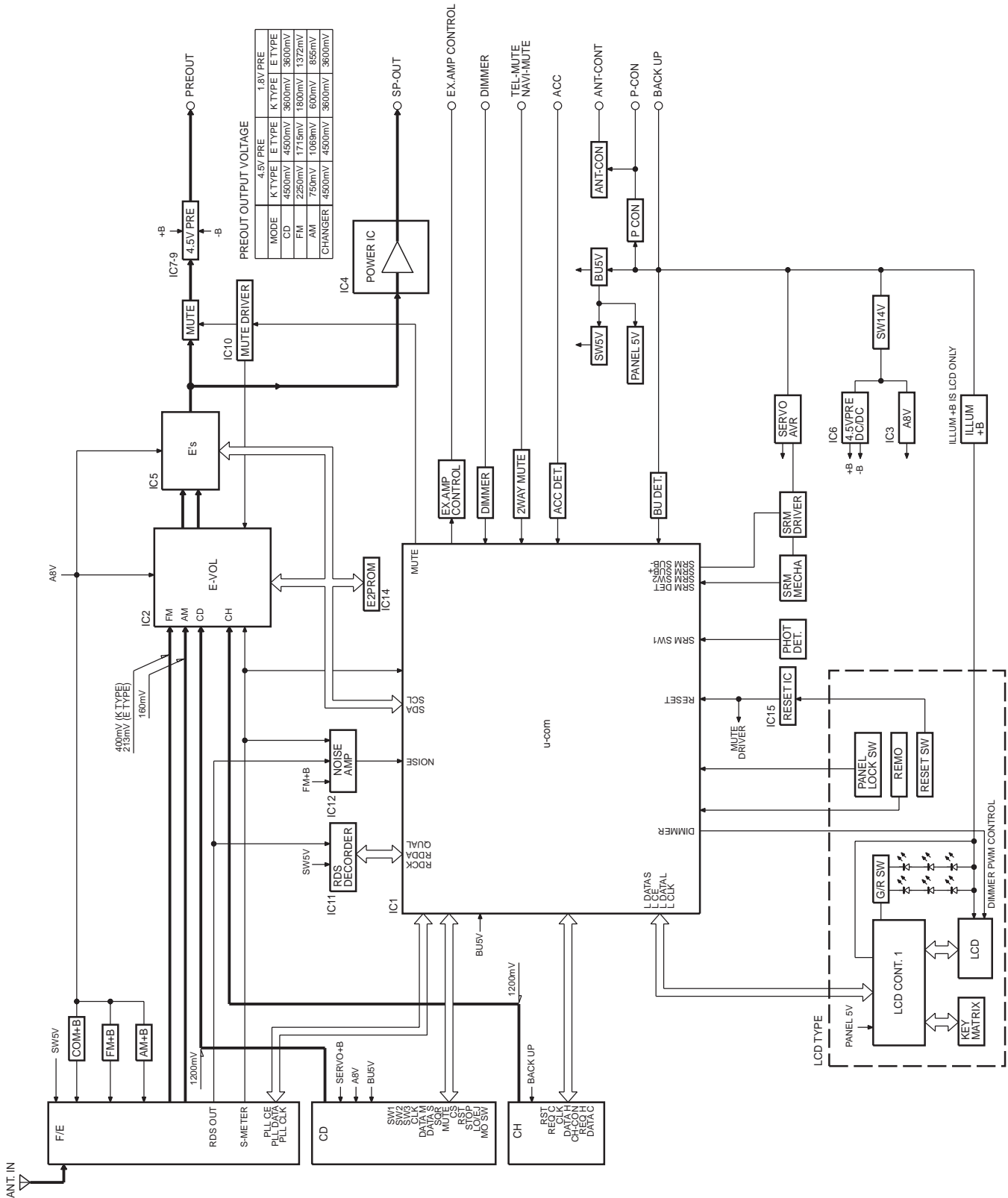

MICROCOMPUTER'S DESCRIPTION

System μ -com : UPD784217GC (X25-)

Terminal description

No.	Pin name	Function	I/O	Description	Processing Operation
1	P120/RTP0	CHCON1	O	Changer 1 control	Active : Hi
2	P121/RTP1	CH_MUTE	I	Changer muting input	MUTE Requested : Hi
3	P122/RTP2	REQH	O	Handshake request to changers	Active : Lo
4	P123/RTP3	ILL_ON	O	Illumination output	Active : Hi
5	P124/RTP4	NC	O	Open	
6	P125/RTP5	CD_SW2	I	12cm DISC detection	ON : Lo
7	P126/RTP6	CD_SW1	I	Loading detection	ON : Lo
8	P127/RTP7	NC	O	Open	
9	Vdd	Vdd	-	Positive power supply	
10	X2	X2	-	Main clock connection	
11	X1	X1	-	Main clock connection	
12	Vss	Vss	-	GND	
13	XT2	XT2	-	Sub clock connection	
14	XT1	XT1	-	Sub clock connection	
15	RESET	RESET	I	Reset input	Active : Lo
16	P00/INTP0	CH_RST	O	Changer reset output	Active : Lo
17	P01/INTP1	R_CLK	I	RDS clock input	
18	P02/INTP2/NMI	REQC	I	Handshake request from changer	Active : Lo
19	P03/INTP3	NC	I/O	-	
20	P04/INTP4	NC	I/O	-	
21	P05/INTP5	NC	I/O	-	
22	P06/INTP6	SC_REQ	I	Handshake request from panel m-com	
23	AVdd	AVdd	-	A/D analog power supply	
24	AVref0	AVref	-	A/D reference voltage input	
25	P10/ANI0	PHONE	I	PHONE detection terminal	1V or less : PHONE 2.5V or more : NAVI MUTE
26	P11/ANI1	SRM_SW1	I	SRM position detection	Open : Hi
27	P12/ANI2	NOISE	I	FM noise detection	Analog input
28	P13/ANI3	SMETER	I	FM signal meter detection	Analog input
29	P14/ANI4	IF_MODE	I	K2I IF selector	Wide : Hi/Narrow : Lo
30	P15/ANI5	NC	I	GND	
31	P16/ANI6	M_MUTE_R	I	Mute request from mechanism	Mute requested : Lo
32	P17/ANI7	M_MUTE_L	I	Mute request from mechanism	Mute requested : Lo
33	AVss	AVss	-	A/D GND	
34	P130/ANO0	EXT_AMP	O	EXT_AMP control	
35	P131/ANO1	M_RST	O	Reset output to mechanism	Reset : Lo
36	AVref1		-	D/A reference voltage input	
37	P70/RxD2/SI2	DATA_C	I	Data line from changer	
38	P71/TxD2/SO2	DATA_H	O	Data line to changer	
39	P72/ASCK2/SCK2	CH_CLK	I/O	Clock line from/to changer	
40	P20/RxD1/SI1	L_DATA/SC_DATA	I	Data line from LCD driver	
41	P21/TxD1/SO1	L_DATAS/MC_DATA	I/O	Data line to LCD driver	
42	P22/ASCK1/SCK1	L_CLK/MC_CLK	I/O	Clock line to LCD driver	
43	P23/PCL	M_STOP	O	Stop request to mechanism	Stop Requested : Lo
44	P24/BUZ	BEEP	O	Beep output	Active : Hi
45	P25/SI0	PLL_CE	O	CE output to PLL	
46	P26/SO0	PLL_DATA	I/O	Data in/out with PLL	
47	P27/SCK0	PLL_CLK	O	Clock output to PLL	
48	P80/A0	CD_SW3	I	Switch detection DOWN	ON : Hi
49	P81/A1	LO/EJ	O	Loading/Eject control	Loading : Lo/Eject : Hi

MICROCOMPUTER'S DESCRIPTION

No.	Pin name	Function	I/O	Description	Processing Operation
50	P82/A2	MOSW	O	Motor output	Loading Hi/Eject : Lo
51	P83/A3	MECH_DET	I	Mechanism detection	ON : Hi/OFF : Lo
52	P84/A4	PAN 5V	O	Panel detection	OFF : Hi
53	P85/A5	L_CE/P_RST	O	CE to LCD driver / Panel m-com reset	
54	P86/A6	L_INH/MC_REQ	O	Reset to LCD driver	
55	P87/A7	DIM_CON	O	DIM control	
56	P40/AD0	QUAL	I	RDS receiving condition	Good : Hi
57	P41/AD1	R_DATA	I	RDS data input	
58	P42/AD2	SRM_SUB-	O	SRM sub motor output	
59	P43/AD3	SRM_SUB+	O	SRM sub motor output	
60	P44/AD4	SRM_DET	I	SRM mechanism detection	ON : Lo/OFF : Hi
61	P45/AD5	SRM_SW2	I	SRM eject detection	┘ : Eject
62	P46/AD6	FM_SD	I	FM SD input	Station detected : Hi Not detected : Lo
63	P47/AD7	NC	O	Open	
64	P50/A8	AFC	O	Noise detection time constant switching	During reception : Hi During search : Lo
65	P51/A9	-	O		
66	P52/A10	WIDE	O	K2I Wide output	Active : Hi
67	P53/A11	NARROW	I/O	K2I Narrow output	Active : Hi
68	P54/A12	AM+B	O	AM power supply	Active : Hi
69	P55/A13	FM+B	O	FM power supply	Active : Hi
70	P56/A14	NC	O	Open	
71	P57/A15	NC	O	Open	
72	Vss		-	GND	
73	P60/A16	TYPE0	I		Destination type switch
74	P61/A17	TYPE1	I		Destination type switch
75	P62/A18	TYPE2	I		Destination type switch
76	P63/A19	ST_TYPE0	I	IC2 Var.3 destination type 0	Initial value : Lo
77	P64/RD	ST_TYPE1	I	IC2 Var.3 destination type 1	Initial value : Lo
78	P65/WR	NC	O	Open	
79	P66/WAIT	PRE MUTE R	O	Audio mute R	Active : Lo
80	P67/ASTB	PRE MUTE L	O	Audio mute L	Active : Lo
81	Vdd		-	Positive power supply	
82	P100/TI5/TO5	NC	O	Open	
83	P101/TI6/TO6	SVR	O	Power IC reset	Power ON : Lo
84	P102/TI7/TO7	NC	O	Open	
85	P103/TI8/TO8	P_MUTE	O	Power IC muting	Active : Lo
86	P30/TO0	ANT_CON	O	Antenna control	Active : Hi
87	P31/TO1	IC2_SCK	O	IC2,IC5,E2PROM clock line	
88	P32/TO2	DIMMER	I	Dimmer detection	Active : Lo
89	P33/TI1	P_CON	O	Power control	Active : Hi
90	P34/TI2	ACC_DET	I	ACC detection	ACC OFF : Hi
91	P35/TI00	REMO	I	Remote control input	
92	P36/TI01	P_ON	O	μ-com peripheral power supply	Active : Hi
93	P37	BU_DET	I	Momentary power down detection	Momentary power down : Hi
94	TEST		-	Test	GND
95	P90	IC2_SDA	I/O	IC2,IC5,E2PROM data line	
96	P91	MUTE	O	Muting output	Active : Hi
97	P92	SW5	O	5V power supply	Active : Lo
98	P93	MS_CL	O	CD mechanism clock line	
99	P94	MS_DA	I/O	CD mechanism data line	
100	P95	-	O	NC	

TEST MODE

1. Entering the test mode

Reset the unit by pressing the FM key and the Preset 6 key at the same time.

When the test mode is entered, all indicators light up.

2. Releasing the test mode

Reset the unit by pressing the preset 6 key.

Note: The unit cannot be reset by simply turning ACC off, turning power off, or turning power off for a brief moment.

3. Voltage adjustment on the FM S-meter

- (1) Enter the test mode.
- (2) While pressing the Preset 1 key, keep on pressing the Preset 6 key.
- (3) When the adjustment is made, "ADJ OK" is displayed. When adjustment cannot be made, "ADJ NG" is displayed.

4. Writing SD voltage for the AM

- (1) Enter the test mode.
- (2) While pressing the Preset 1 key, keep on pressing the Preset 6 key, which results in writing SD.

5. Forced switching of K2I Auto/Manual

In tuner-mode, keeping on pressing TI key, and the Auto and Manual modes can be switched. The initial condition is in manual modes, which is indicated by flashing DUAL dots.

6. Forced narrow/wide switching of K2I

In tuner-mode, when Preset 6 is pressed, forced narrow/wide mode switching is made. The initial condition is in wide mode and the NEWS dot flashes.

7. CD receiver test mode specification

By pressing the track-up key, the unit jumps to the following tracks:

No.9 → No.15 → No.10 → No.11 → No.12 → No.13 → No.14 → No.9 (Goes back to the first position.)

When the track-down key is pressed, the unit jumps to the previous track.

8. MD test mode specification

After loading MD, the unit plays No.7. Then, the unit jumps as follows each time it trackups.

No.2 → No.13 → No.23 → No.30 → No.34 → No.7 (Goes back to the first position.)

When the track-down key is pressed, the unit jumps to the previous track.

9. Tape test mode

In the initial step, the blank skip is turned off.

10. Audio-related items

- The volume is -10dB (on display, it is 30).
- The loudness is off and CRSC is off regardless of functions.
- Buss/treble and balance/fader are to be adjusted by the up/down key to full-boost/fullcut and fullfront/fullrear respectively.
- The high-pass filter is adjusted by the up-key to throughput/100Hz/200Hz and, by the down-key, to 200Hz/100Hz/throughput.
- Other adjustments are the same as before.

11. Backup current measurement

When reset in ACC-off condition (backup is on), the mute terminal goes off after 2 seconds instead of 15 seconds, when the ACC is turned off in the test mode. (In this case, the panel/CD/C/MD mechanisms are not activated.)

12. Registering security code after changing E2PROM at the services (Only for type M. However, RDS models are excluded.)

- (1) Put the unit into the test mode (Refer to 1. Above for how to enter the test mode.)
- (2) Press SRC key to put the unit into the tuner mode.
- (3) Press Audio key for one second and put the unit into the menu mode.
- (4) Press FM/AM key and then select "SECURITY."
- (5) Press track up/down key for full 2 seconds.
- (6) Press Preset 1, Preset 2, Preset 3, and Preset 4 and then input codes.

Example: Inputting "3510."

 - Press 1 key 4 times.
 - Press 2 key 6 times.
 - Press 3 key 2 times.
 - Press 4 key once.
- (7) Press DISP key for 3 seconds and confirm that "APPROVED" is displayed.
- (8) Release the test mode. (Refer to "2. Releasing the test mode" above.)

TEST MODE

13. Simplified method for clearing the security code (Only for type K)

- (1) When code is requested, continue pressing VOL UP key for three seconds while pressing the DISP key. (...disappear.)
- (2) Input "KCAR," using the remote controller (the same as the 98 Model)
 - Press Tenkey 5 twice and then press track-up key. (Inputting "K")
 - Press Tenkey 2 three times and then press track-up key. (Inputting "C")
 - Press Tenkey 2 once and then press track-up key. (Inputting "A")
 - Press Tenkey 7 twice and then press track-up key. (Inputting "R")
- (3) Then, the security is released and the unit goes into the Tuner Mode.

14. Writing MASK KEY on line (E2PROM in initial condition)

- (1) While pressing the FM key and Preset 6 key, press reset key to enter the test mode.
- (2) Press AUDIO key for full one second to put the unit into the menu mode.
- (3) Select the "MASK KEY," using the FM key or AM key.
- (4) Press on the track up/down key to display "TRANSMIT 1."
- (5) Point the MASK KEY to the light receptor and press it for 0.5 second or longer.
- (6) When "TRANSMIT 2" is displayed, press MASK KEY for 0.5 second or longer. When this is conducted, the counter codes for the first time and the second time will not be compared.
- (7) When "APPROVED" is displayed, writing is completed. time the demonstration mode is set and the test mode is released.

Note: After an elapse of 30-minute period, during which no code is written, an error is effected and the device will power off.

15. Releasing MASK KEY requests (When reset or backup is off when MASK KEY is approved)

- (1) When power is turned on, "TRANSMIT 1" is displayed and the unit goes into MASK KEY request mode.
- (2) Point the MASK KEY to the light receptor and press it for more than 3 seconds (until the level display indicates full)
- (3) When "TRANSMIT 2" is displayed, press the MASK KEY again for more than three seconds. At this point, when "TRANSMIT 1" is displayed, repeat the process in (2) above for the second time.
- (4) When "APPROVED" is displayed, MASK KEY is approved and the unit turns power on.

16. Initializing MASK KEY (returning to the default condition from MASK KEY approved state)

- (1) While pressing the FM key and Preset 6 key at the same time, press RESET to enter the test mode.
- (2) "TRANSMIT 1" is displayed and the unit goes into MASK KEY request mode. The display at this point will be "****" instead of "[]".
- (3) Use MASK KEY release remote controller for more than three seconds.
- (4) When "TRANSMIT 2" is displayed,press the MASK KEY for more than three seconds for the second time.
- (5) When "APPROVED" is displayed, the MASK KEY is released and the demonstration mode is set. Then, the test mode is released, returning the unit into default condition.

17. Clearing from the MASK KEY

- (1) While pressing FM key and Preset 6 key at the same time,press RESET to enter the test mode.
- (2) Press the AUDIO key for full one second to put the unit into the menu mode.
- (3) Select MASK KEY, using track up/down key.
- (4) Press on the FM key or AM key for full two seconds and the unit will display "TRANSMIT 1."
- (5) Point the MASK KEY release controller to the light receptor and press it for 3 seconds or longer. (Until the level display indicates full.)
- (6) When "TRANSMIT 2" is displayed, press MASK KEY for 3 seconds or longer for the second time. If "TRANSMIT 1" is displayed, start again from (5) above.
- (7) When "APPROVED" is displayed, E2PROM is cleared. The unit goes back to the condition described in Line 14: Writing MASK KEY on line (E2PROM in initial condition)

18. Other

- Automatic panel closing does not occur in case a TAPE,CD, or MD is inserted.
- Panel is opened/closed when ATT key is turned On/Off. (A remote controller is used when tuning ATT on.)
- The DNPP/SBF key of the remote controller (RC-510) is used for tuning the menu mode On/Off.
- The OPEN/CLOSE key of the remote controller (RC-510) is used for tuning the audio mode On/Off.
- The feed on the menu will be feeds only for necessary features.
- "CODE OFF" and other displays will not be issued when the power is turned on.
- The dimmer of the FL model and contrast on the LCD model can be adjusted only for 0/5/10 by the UP/DOWN key.

PC BOARD (COMPONENT SIDE VIEW)

ELECTRIC UNIT (X25-8470-13)

SWITCH UNIT (X13-9720-10)

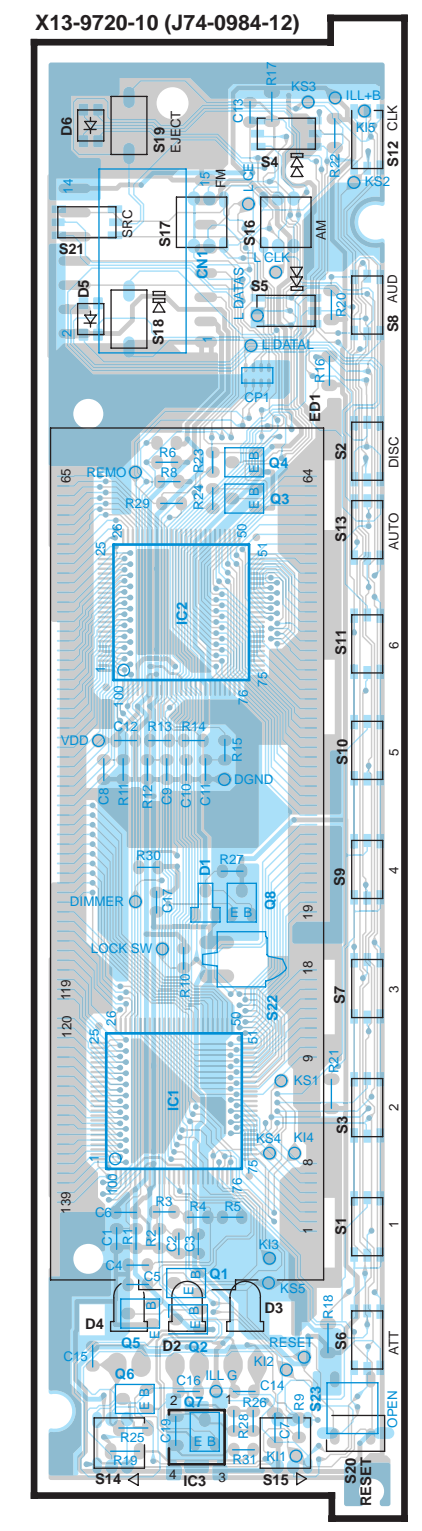
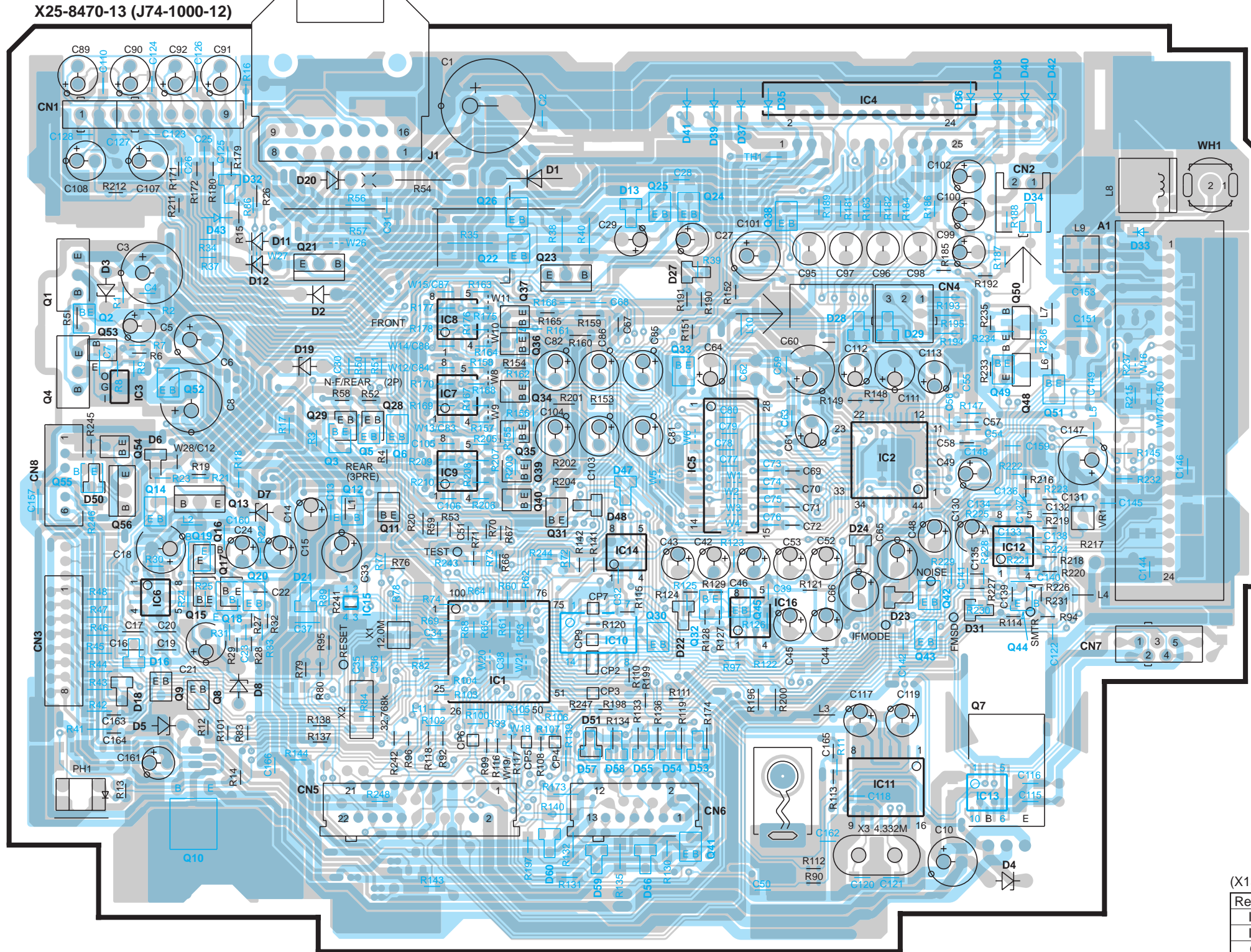

(X25-8470-13)

Ref. No.	IC1	IC2	IC3	IC4	IC5	IC6	IC7	IC8	IC10	IC11	IC13	IC14	IC15												
Address	5D	4F	3B	2F	4E	5B	3C	3C	5D	6F	6F	4D	5C												
Ref. No.	Q1	Q2	Q3	Q4	Q5	Q6	Q7	Q8	Q9	Q10	Q11	Q12	Q13	Q14	Q15	Q16	Q17	Q18	Q19	Q20	Q21	Q22			
Address	3A	3B	4C	3A	4C	4C	5F	5B	5B	6B	4C	4C	4B	4B	5B	4B	4B	5B	4B	4B	3C	3D			
Ref. No.	Q23	Q24	Q25	Q26	Q28	Q29	Q30	Q31	Q33	Q34	Q35	Q36	Q37	Q38	Q41	Q48	Q49	Q50	Q51	Q52	Q53				
Address	3D	2E	2E	2D	4C	4C	5E	4D	3E	3D	4C	3D	3D	3E	6E	3G	3F	3G	4G	3B	3B				

(X13-9720-10)

Ref. No.	Address
IC1	5I
IC3	6I
Q1	6I
Q2	6I
Q3	3I
Q4	3I
Q5	6I
Q6	6I
Q7	6I
Q8	4I

Refer to the schematic diagram for the values of resistors and capacitors.

PC BOARD (FOIL SIDE VIEW)

SWITCH UNIT (X13-9720-10)

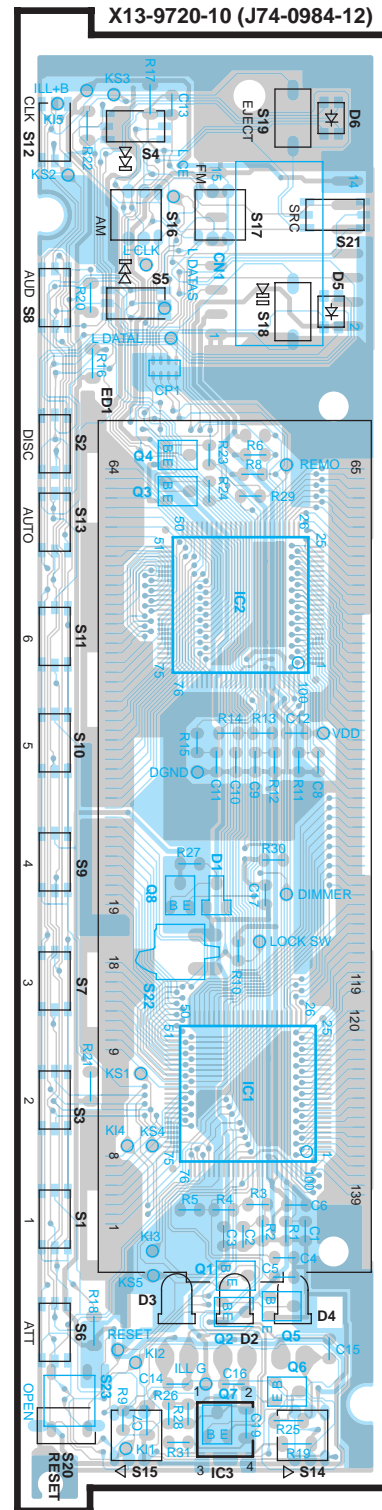

(X13-9720-10)

Ref. No.	Address
IC1	5L
IC3	6L
Q1	6L
Q2	6L
Q3	3L
Q4	3L
Q5	6L
Q6	6L
Q7	6L
Q8	4L

ELECTRIC UNIT (X25-8470-13)

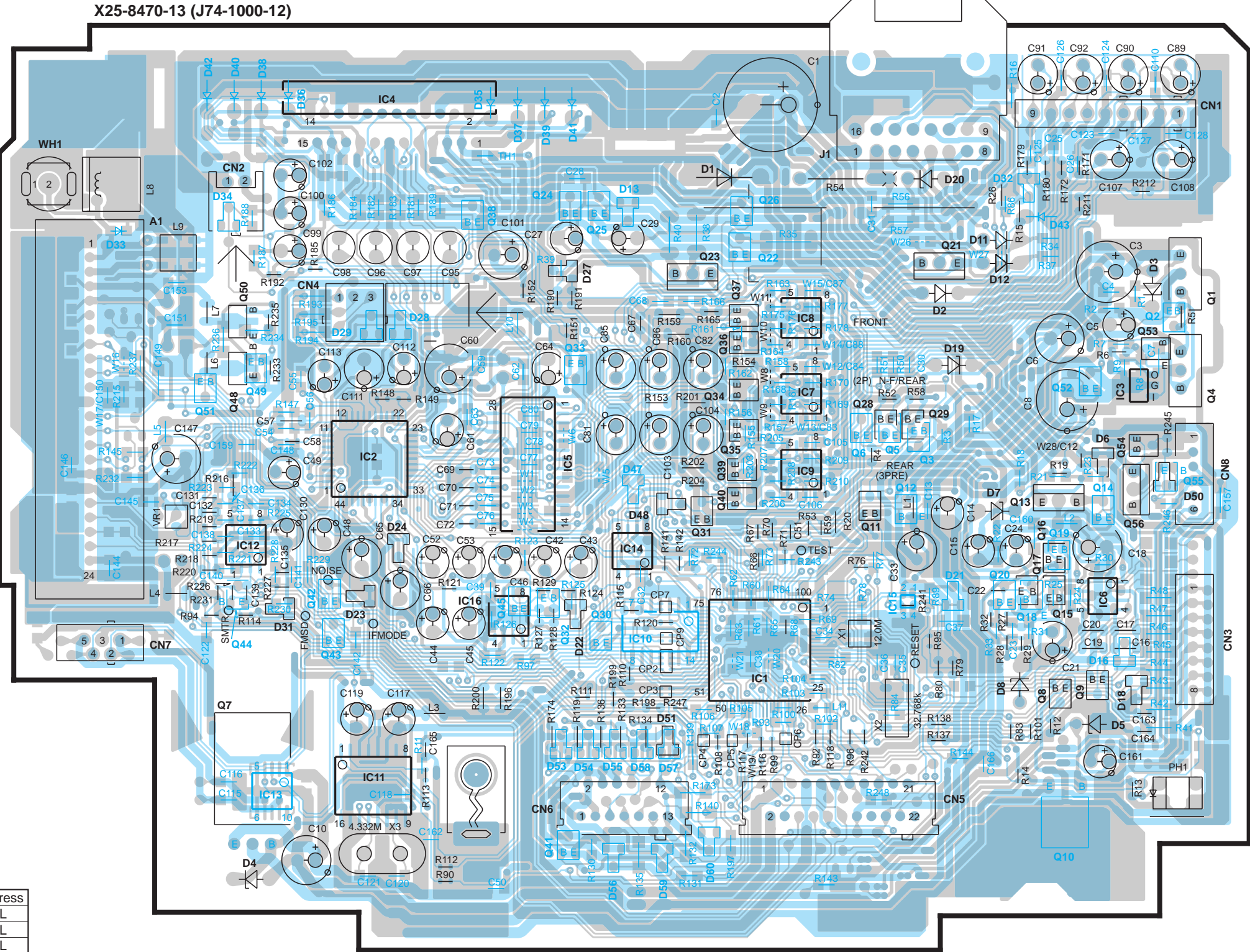

(X25-8470-13)

Ref. No.	IC1	IC2	IC3	IC4	IC5	IC6	IC7	IC8	IC10	IC11	IC13	IC14	IC15												
Address	5Q	4O	3S	2O	4P	5S	3R	3R	5Q	6O	6O	4Q	5R												
Ref. No.	Q1	Q2	Q3	Q4	Q5	Q6	Q7	Q8	Q9	Q10	Q11	Q12	Q13	Q14	Q15	Q16	Q17	Q18	Q19	Q20	Q21	Q22			
Address	3T	3S	4R	3T	4R	4R	5N	5S	5S	6S	4R	4R	4S	4S	5S	4S	4S	5S	4S	4S	3R	3Q			
Ref. No.	Q23	Q24	Q25	Q26	Q28	Q29	Q30	Q31	Q33	Q34	Q35	Q36	Q37	Q38	Q41	Q48	Q49	Q50	Q51	Q52	Q53				
Address	3Q	2P	3P	2Q	4R	4R	5P	4Q	3P	3Q	4Q	3Q	3Q	3P	6P	3N	3O	3N	4N	3S	3S				

Refer to the schematic diagram for the values of resistors and capacitors.

PC BOARD (COMPONENT SIDE VIEW)

CD PLAYER UNIT (X32-4740-00)

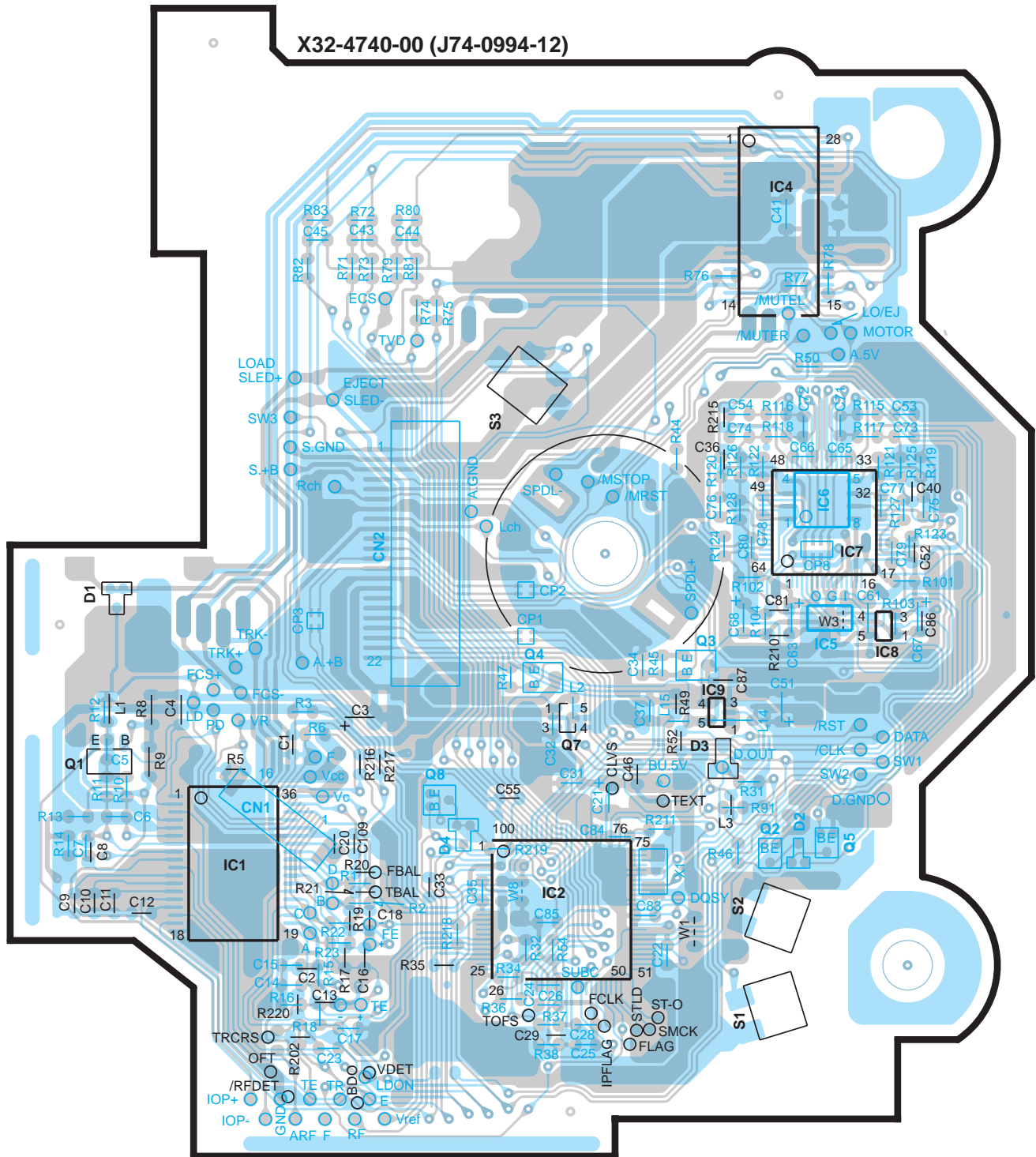

(X32-4740-00)

Ref. No.	IC1	IC2	IC4	IC5	IC6	IC7	IC8	IC9
Address	5V	5W	2X	4X	4X	4X	4X	4X
Ref. No.	Q1	Q2	Q3	Q4	Q5	Q7	Q8	
Address	5U	5X	4X	4W	5X	5W	5W	

Refer to the schematic diagram for the values of resistors and capacitors.

PC BOARD (FOIL SIDE VIEW)

CD PLAYER UNIT (X32-4740-00)

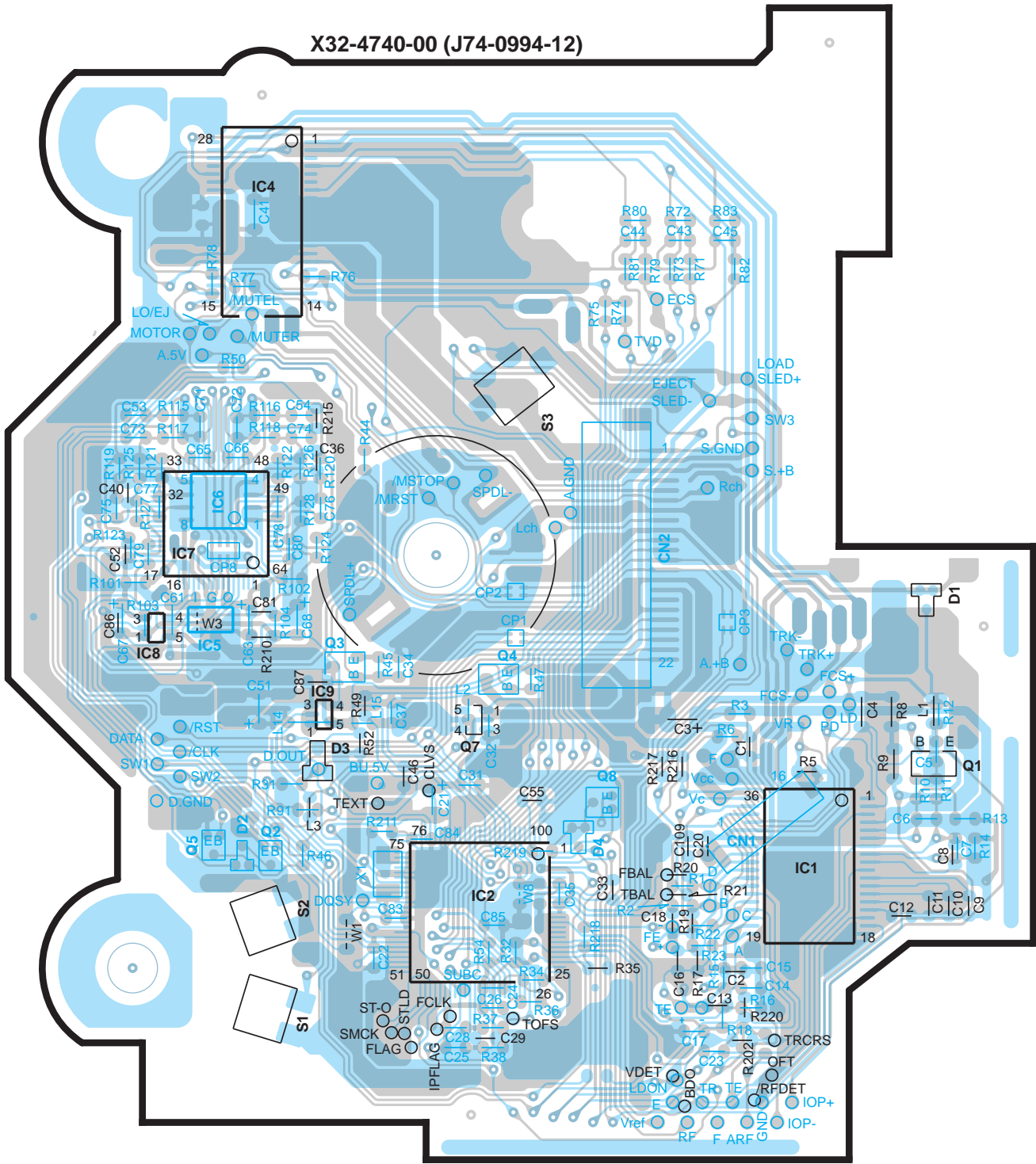

(X32-4740-00)

Ref. No.	IC1	IC2	IC4	IC5	IC6	IC7	IC8	IC9
Address	5AC	5AB	2AA	4AA	4AA	4AA	4AA	4AA
Ref. No.	Q1	Q2	Q3	Q4	Q5	Q7	Q8	
Address	5AD	5AA	4AA	4AB	5AA	5AB	5AC	

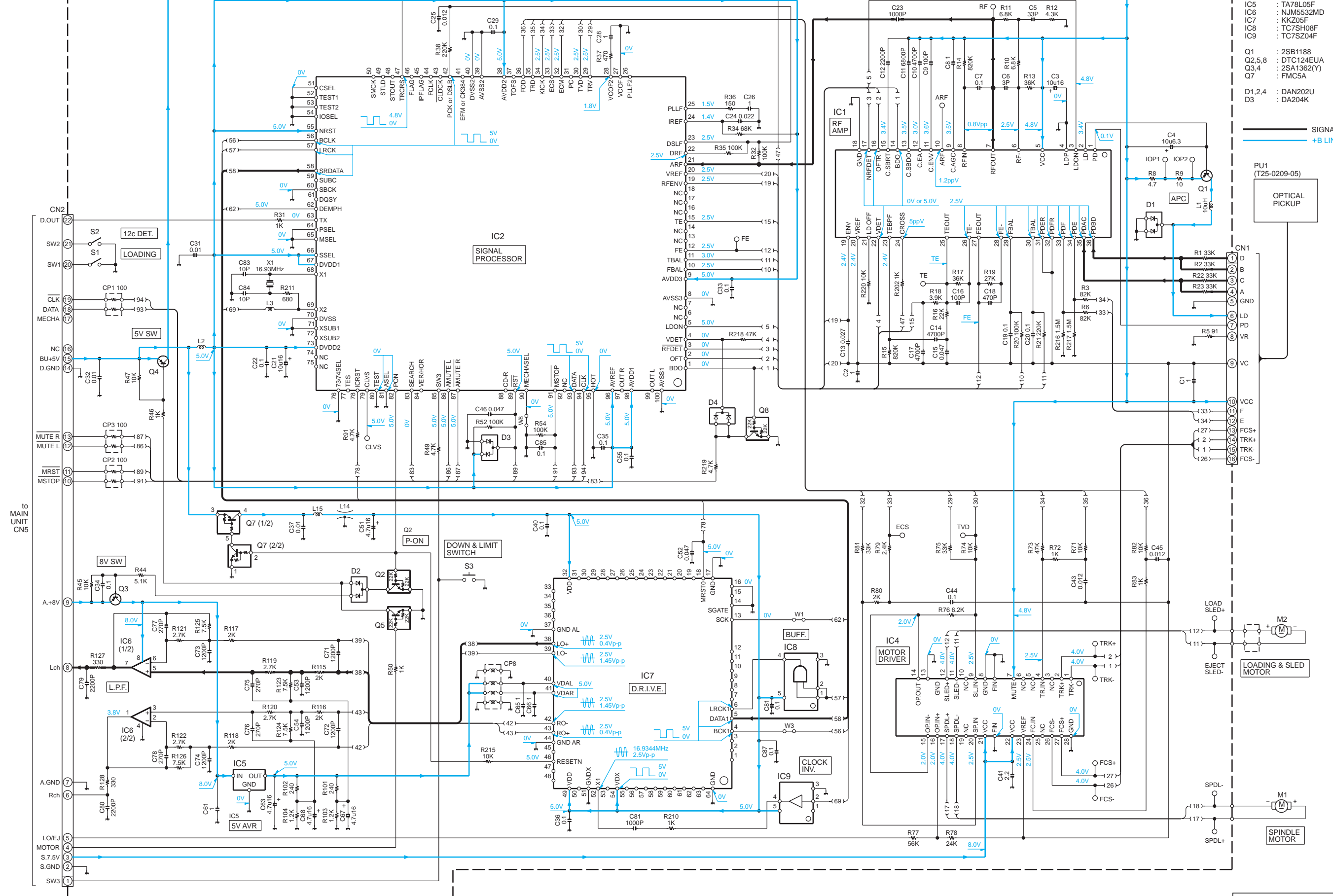

- IC1 : AN8806SB
- IC2 : MN662773KB3
- IC4 : BA5917AFP
- IC5 : TA78L05F
- IC6 : NJM5532MD
- IC7 : KKZ05F
- IC8 : TC7SH08F
- IC9 : TC7SZ04F

- Q1 : 2SB1188
- Q2,5,8 : DTC124EUA
- Q3,4 : 2SA1362(Y)
- Q7 : FMC5A

- D1,2,4 : DAN202U
- D3 : DA204K

— SIGNAL LINE
 — +B LINE

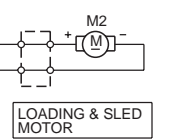
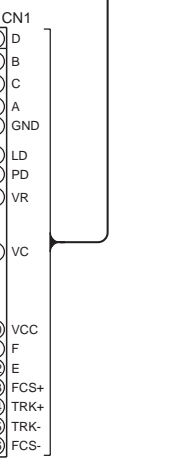
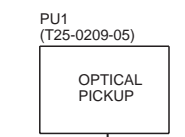

CAUTION: For continued safety, replace safety critical components only with manufacturer's recommended parts (refer to parts list). ⚠ Indicates safety critical components. To reduce the risk of electric shock, leakage-current or resistance measurements shall be carried out (exposed parts are acceptably insulated from the supply circuit) before the appliance is returned to the customer.

•DC voltages are as measured with a high impedance voltmeter. Values may vary slightly due to variations between individual instruments or/and units.

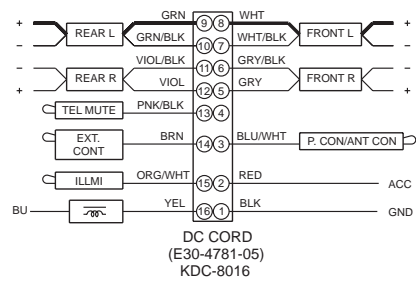
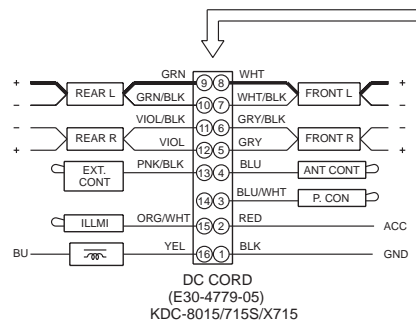

(X25-847X-XX)

MODEL NAME	UNIT No.	©	Ⓢ	IC5	IC7.8
KDC-X715	70-13	YES	YES	YES	YES
KDC-8015	70-14	YES	NO	NO	YES
KDC-715S	70-15	NO	NO	NO	NO
KDC-8016	70-22	NO	NO	NO	NO

MODEL NAME	Q11	D32	R26,86,90,112,113	R60	R61	R62	R63,167-170,175-178
KDC-X715	YES	YES	YES	NO	YES	NO	YES
KDC-8015	NO	NO	NO	YES	NO	NO	YES
KDC-715S	NO	NO	NO	NO	YES	YES	NO
KDC-8016	NO	NO	NO	YES	YES	NO	NO

MODEL NAME	R82	R157,158,163,164	C48,49,52,53,62,64,69-90	C81,82,85,86	W1-6	W8-15
KDC-X715	NO	NO	YES	22u16	NO	NO
KDC-8015	YES	YES	NO	22u16	YES	NO
KDC-715S	YES	YES	NO	10u16	YES	YES
KDC-8016	YES	YES	NO	10u16	YES	YES

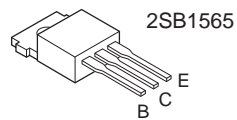

- DTA114EK DTC144EK
- DTA123JK KRC103S
- DTA124EK 2SA1362
- DTB123YK 2SB706A
- DTC114EK 2SC2412K
- DTC114YK 2SD2114K
- DTC124EK

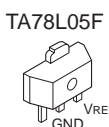
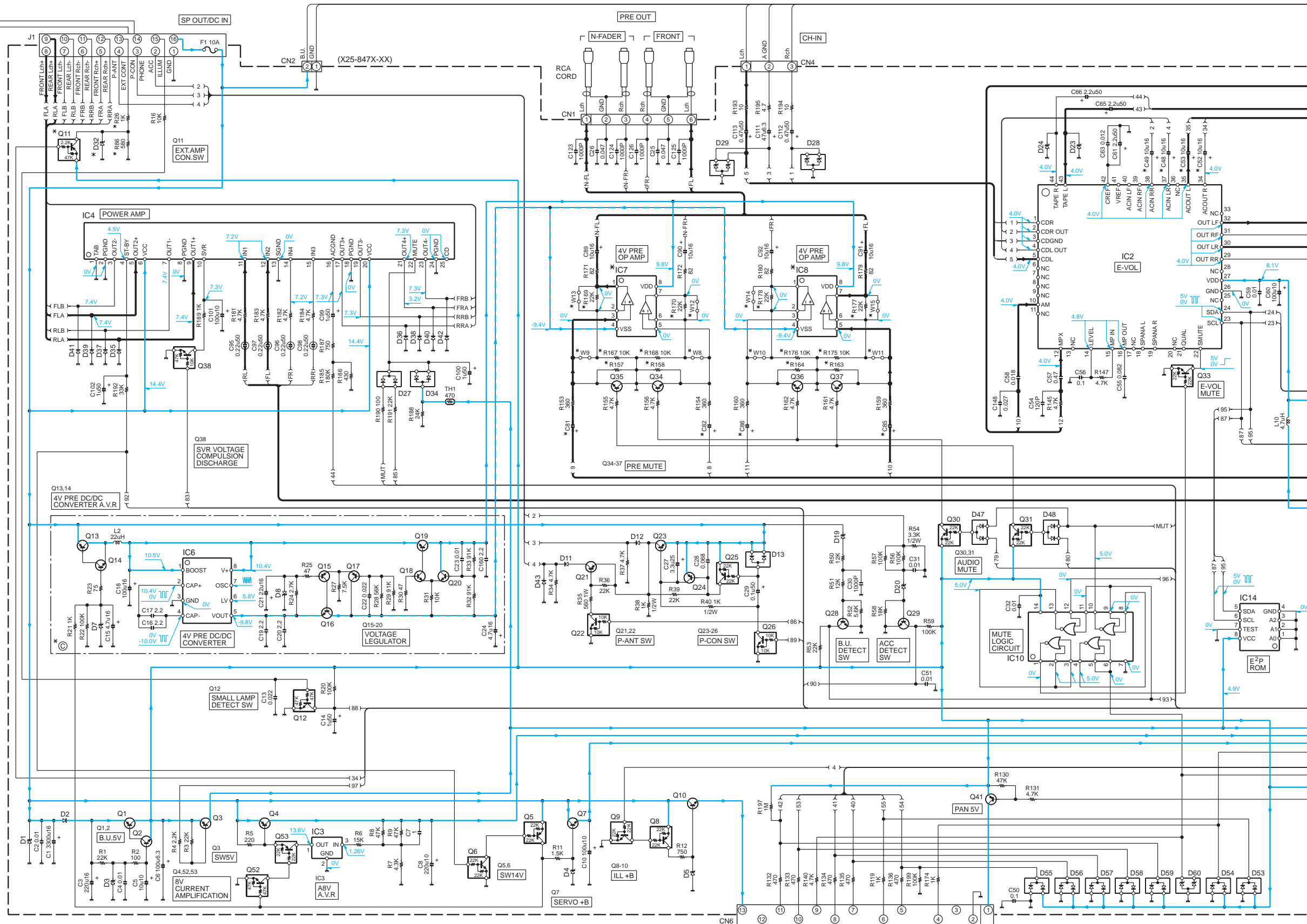
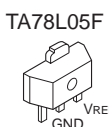
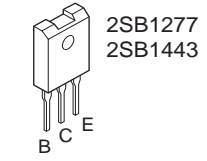

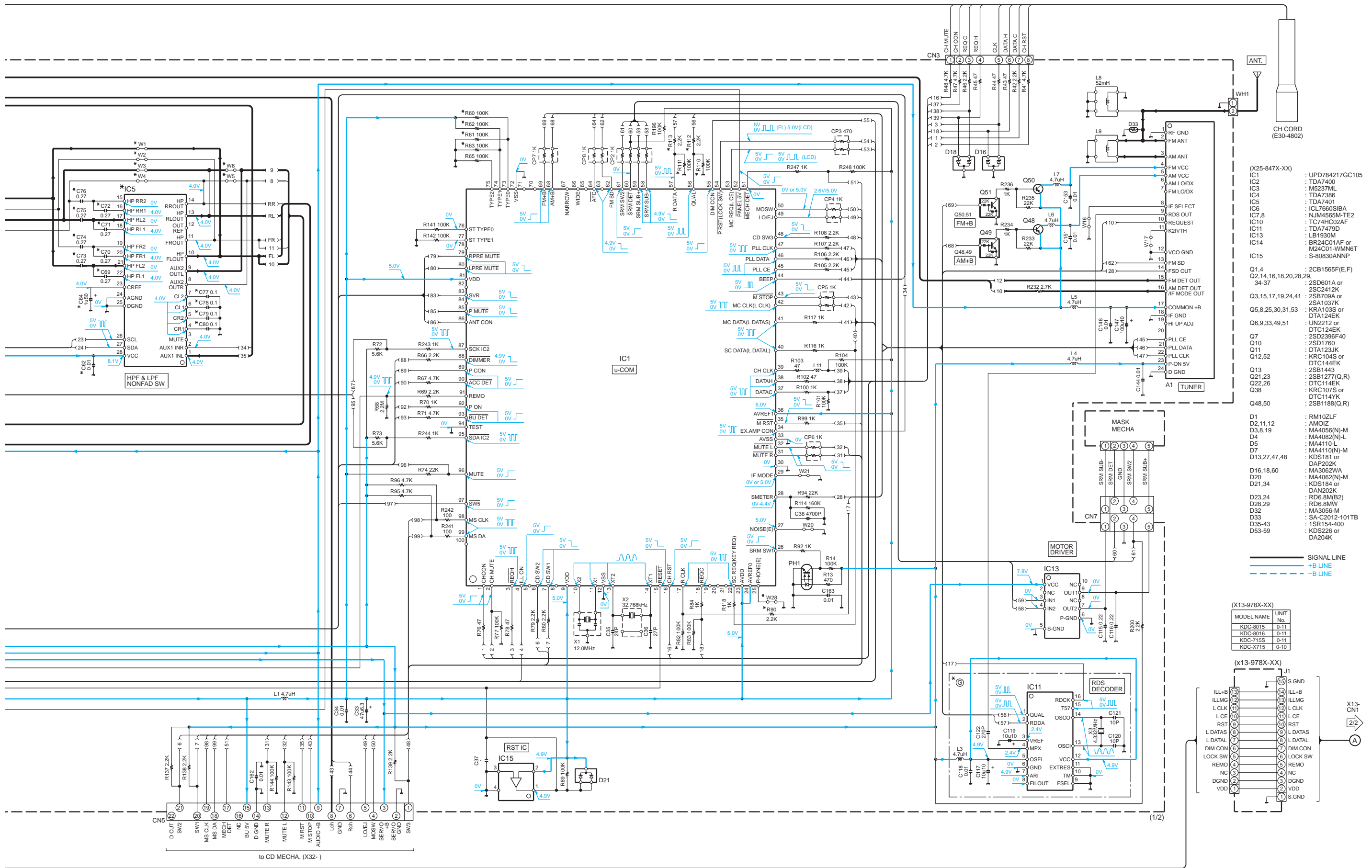

CAUTION: For continued safety, replace safety critical components only with manufacturer's recommended parts (refer to parts list). ⚠ Indicates safety critical components. To reduce the risk of electric shock, leakage-current or resistance measurements shall be carried out (exposed parts are acceptably insulated from the supply circuit) before the appliance is returned to the customer.

•DC voltages are as measured with a high impedance voltmeter. Values may vary slightly due to variations between individual instruments or/and units.

KDC-X715
KENWOOD

(X13-972X-XX)

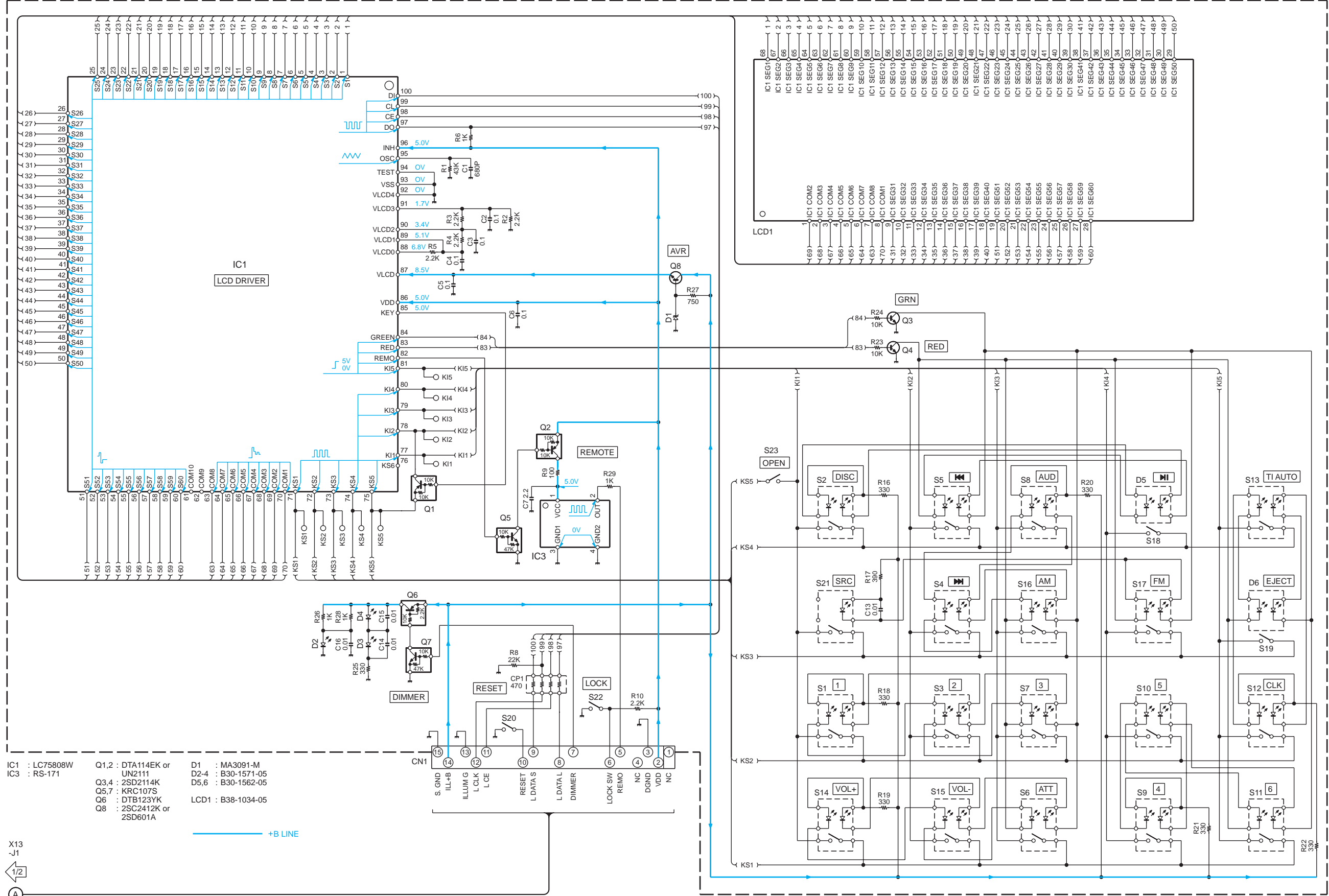

- | | | |
|----------------|---------------------------|--------------------|
| IC1 : LC75808W | Q1,2 : DTA114EK or UN2111 | D1 : MA3091-M |
| IC3 : RS-171 | Q3,4 : 2SD2114K | D2-4 : B30-1571-05 |
| | Q5,7 : KRC107S | D5,6 : B30-1562-05 |
| | Q6 : DTB123YK | LCD1 : B38-1034-05 |
| | Q8 : 2SC2412K or 2SD601A | |



+B LINE

(2/2)

CAUTION: For continued safety, replace safety critical components only with manufacturer's recommended parts (refer to parts list). ⚠ Indicates safety critical components. To reduce the risk of electric shock, leakage-current or resistance measurements shall be carried out (exposed parts are acceptably insulated from the supply circuit) before the appliance is returned to the customer.

•DC voltages are as measured with a high impedance voltmeter. Values may vary slightly due to variations between individual instruments or/and units.



EXPLODED VIEW (MECHANISM)

- | | | |
|---|-------------|---------------|
| A | M1.7x2.5 | : N09-4249-05 |
| B | φ2x3.5 | : N09-4172-05 |
| C | M1.7x4 | : N09-4202-05 |
| D | M2x2 | : N38-2020-46 |
| E | φ2x6 | : N09-4294-05 |
| F | WASHER φ1.2 | : N19-2023-04 |
| G | WASHER φ1.6 | : N19-2058-04 |
| H | WASHER φ1.6 | : N19-2093-04 |

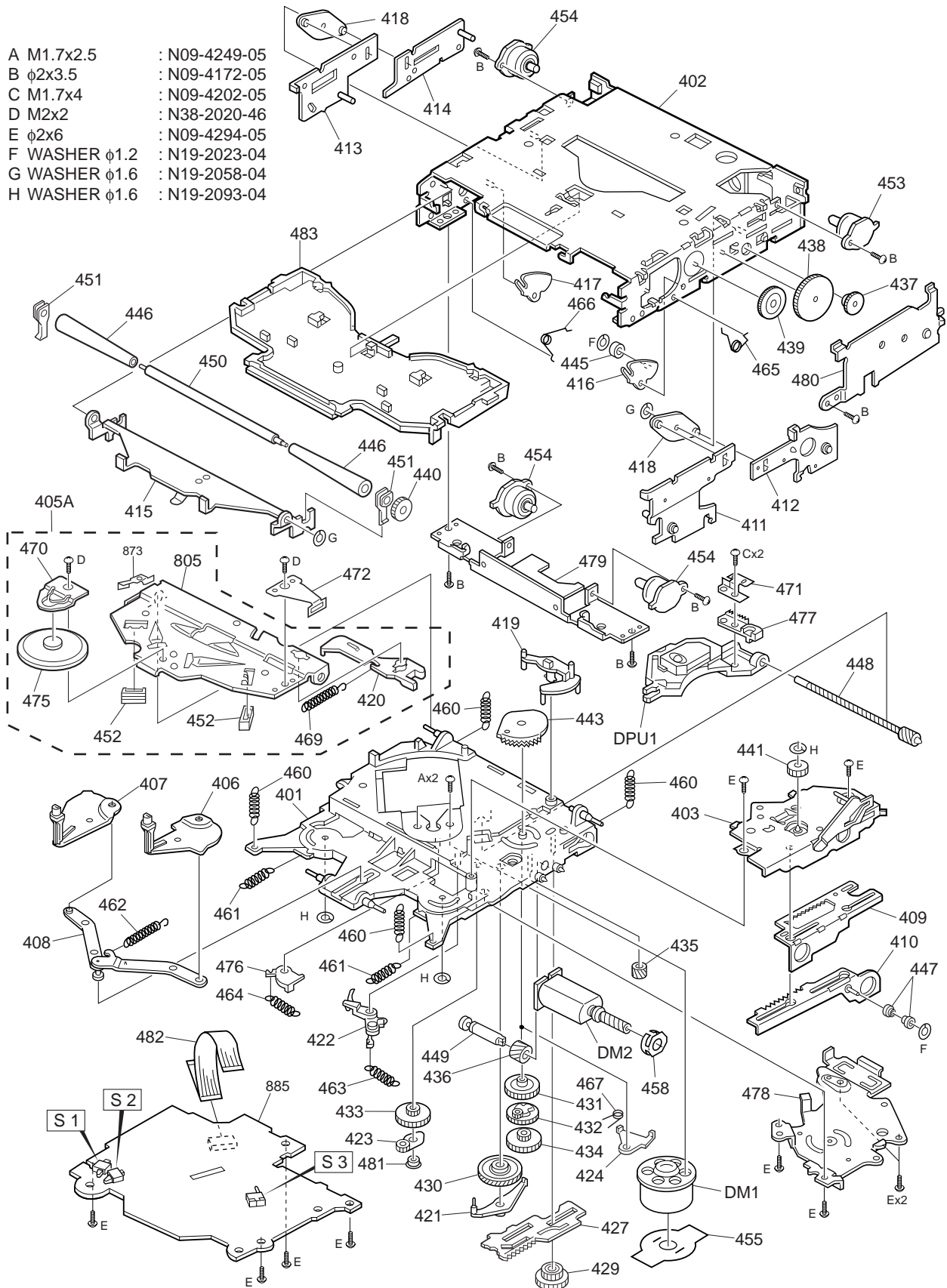

Parts with the exploded numbers larger than 700 are not supplied.

EXPLODED VIEW (UNIT)

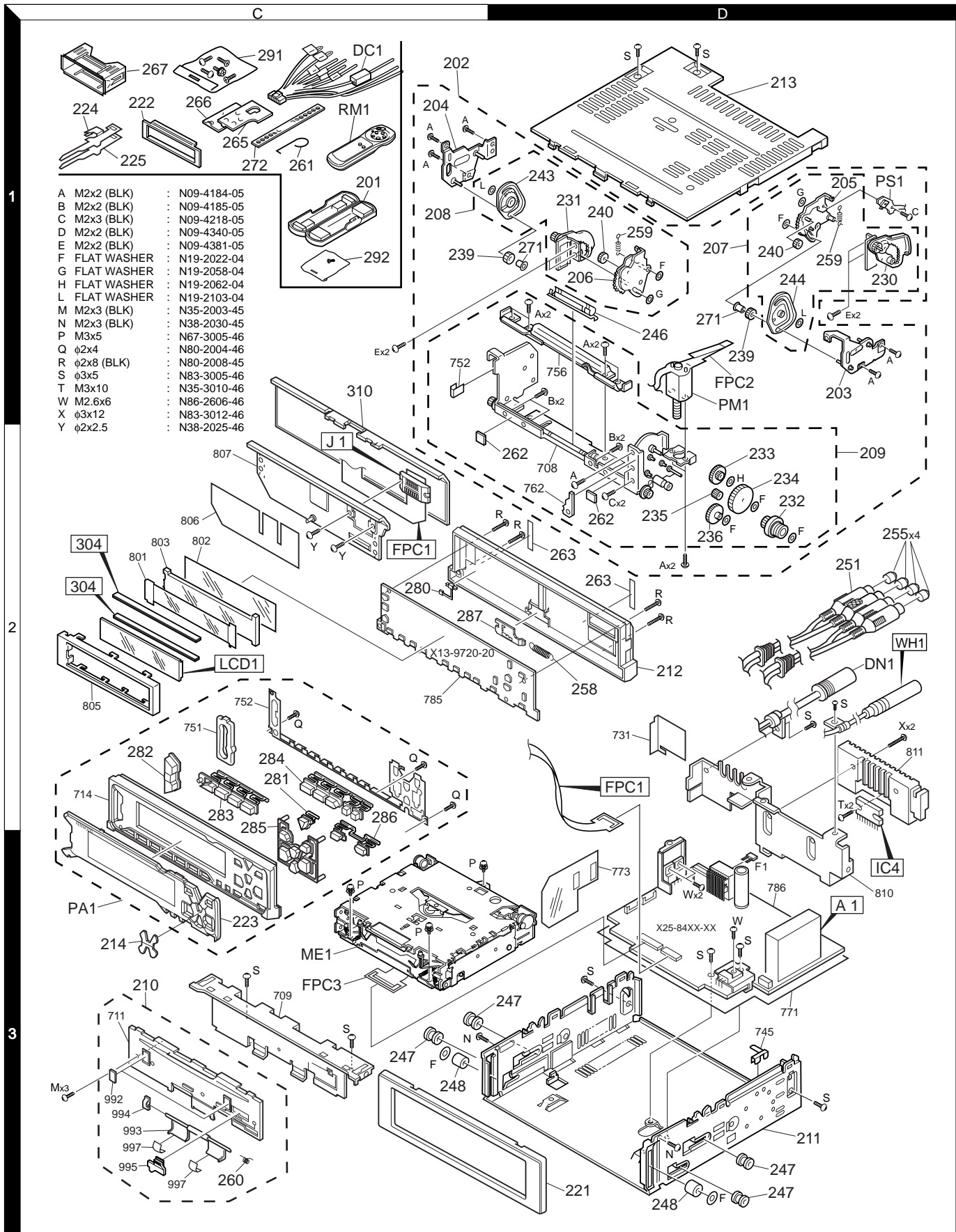

Parts with the exploded numbers larger than 700 are not supplied.

PARTS LIST

* New Parts

Parts without **Parts No.** are not supplied.

Les articles non mentionnes dans le **Parts No.** ne sont pas fournis.

Teile ohne **Parts No.** werden nicht geliefert.

Ref. No.	A d d	N e w	Parts No.	Description	Desti nati on
KDC-X715					
201	1C		A02-1489-03	PLASTIC CABINET ASSY	
202	1C		A10-4671-02	CHASSIS ASSY	
203	1D		A10-4315-04	CHASSIS CALKING ASSY	
204	1C		A10-4317-04	CHASSIS CALKING ASSY	
205	1D		A10-4319-04	CHASSIS CALKING ASSY	
206	1D		A10-4321-04	CHASSIS CALKING ASSY	
207	1D		A10-4674-02	CHASSIS ASSY	
208	1D		A10-4676-02	CHASSIS ASSY	
209	2D		A10-4534-23	CHASSIS ASSY	
210	3C		A22-2296-43	SUB PANEL ASSY	
211	3D		A10-4666-03	CHASSIS ASSY	
212	2D		A46-1652-01	REAR COVER	
213	1D		A52-0742-12	TOP PLATE	
214	3C		A21-4011-03	DRESSING PANEL	
PA1	3C		A64-1870-02	PANEL ASSY	
RM1	1C		A70-0894-05	REMOTE CONTROLLER ASSY	
221	3D		B07-2146-03	ESCUTCHEON ASSY	
222	1C		B07-2183-02	ESCUTCHEON	
223	3C	*	B10-3110-01	FRONT GLASS	
-			B46-0100-50	WARRANTY CARD	
-			B46-0606-04	ID CARD	
-			B46-0631-03	USER CARD	
-			B58-1278-04	CAUTION CARD	
-		*	B64-1603-00	INSTRUCTION MANUAL E	
-		*	B64-1604-00	INSTRUCTION MANUAL F,S	
224	1C		D10-4301-14	LEVER	
225	1C		D10-4302-14	LEVER	
230	1D		D10-4448-03	ARM ASSY	
231	1D		D10-4449-04	ARM ASSY	
232	2D		D13-1302-64	GEAR ASSY	
233	2D		D13-1306-24	GEAR	
234	2D		D13-1403-03	GEAR	
235	2D		D13-1404-04	GEAR	
236	2D		D13-1453-14	GEAR ASSY	
239	1D		D13-1312-34	GEAR	
240	1D		D13-1313-04	GEAR	
243	1D		D13-1456-13	GEAR ASSY	
244	1D		D13-1455-13	GEAR ASSY	
246	1D		D14-0678-04	ROLLER ASSY	
247	3D		D14-0723-04	ROLLER	
248	3D		D14-0716-14	ROLLER	
251	2D		E30-4798-05	CORD WITH PINPLUG	
△ DC1	1C		E30-4779-05	DC CORD	
△ DN1	2D		E30-4802-05	CORD WITH DIN CONNECTOR	
255	2D		F29-0049-05	INSULATING COVER	
△ F1			F52-0011-05	FUSE(MINI BLADE TYPE)	
△ F1	3D		F52-0006-05	FUSE(MINI BLADE TYPE)	
258	2D		G01-2984-04	EXTENSION SPRING	
259	1D		G01-2818-24	EXTENSION SPRING	
260	3C		G01-2920-14	TORSION COIL SPRING	
261	1C		G01-2924-04	TORSION COIL SPRING	

Ref. No.	A d d	N e w	Parts No.	Description	Desti nati on
262	2D		G11-1850-04	CUSHION	
263	2D		G16-1147-04	SHEET	
-			H10-4700-02	POLYSTYRENE FOAMED FIXTURE	
-			H21-1123-04	PROTECTION SHEET	
-			H25-0329-04	PROTECTION BAG (280X450X0.03)	
-			H25-0337-04	PROTECTION BAG (180X300X0.03)	
-			H25-1108-04	PROTECTION BAG (100X300X0.03)	
-		*	H54-1655-03	ITEM CARTON CASE	
265	1C		J19-4875-04	BRACKET	
266	1C		J19-4876-04	BRACKET	
267	1C		J21-9491-03	MOUNTING HARDWARE ASSY	
271	1D		J31-1035-24	COLLAR	
272	1C		J54-0606-04	STAY	
FPC2	1D		J84-0062-23	FLEXIBLE PRINTED WIRING BOARD	
FPC3	3C		J84-0066-13	FLEXIBLE PRINTED WIRING BOARD	
280	2C		K24-3540-03	KNOB OPEN	
281	2C		K24-3541-04	KNOB SRC	
282	2C		K25-1095-03	KNOB VOL	
283	2C		K25-1096-03	KNOB 1-3	
284	2C		K25-1097-03	KNOB 4-6	
285	2C		K25-1098-03	KNOB FM/AM	
286	2C		K25-1099-03	KNOB CLK	
287	2C		K29-7010-04	KNOB ASSY LOCK	
291	1C		N99-1652-05	SCREW SET	
292	1C		N99-1683-05	SCREW SET	
A	1D		N09-4184-05	MACHINE SCREW (M2X2 2)	
B	1D		N09-4185-05	MACHINE SCREW (M2X2)	
C	1D		N09-4218-05	MACHINE SCREW (M2X 3)	
D	1D		N09-4340-05	MACHINE SCREW (M2X2.)	
E	1D		N09-4381-05	MACHINE SCREW (M2X2)	
F	2D		N19-2022-04	FLAT WASHER	
G	1D		N19-2058-04	FLAT WASHER	
H	2D		N19-2062-04	FLAT WASHER	
J	1D		N19-2085-04	FLAT WASHER	
K	1D		N19-2095-04	FLAT WASHER	
L	1D		N19-2103-04	FLAT WASHER	
M	3C		N35-2003-45	BINDING HEAD MACHINE SCREW	
N	3C		N38-2030-45	PAN HEAD MACHIN SCREW	
P	3C		N67-3005-46	PAN HEAD SEMS SCREW	
Q	2C		N80-2004-46	PAN HEAD TAPTITE SCREW	
R	2D		N80-2008-45	PAN HEAD TAPTITE SCREW	
S	1D		N83-3005-46	PAN HEAD TAPTITE SCREW	
PS1	1D		S68-0829-05	PUSH SWITCH	
PM1	1D		T42-0752-34	MOTOR ASSY	
ME1	3C		X92-3710-00	MECHANISM ASSY	
SWITCH UNIT(X13-9720-10)					
D2 -4			B30-1571-05	LED(WHITE)	
D5 ,6			B30-1562-05	LED	
LCD1	2C		B38-1034-05	LIQUID CRYSTAL	
C1			CK73FB1H681K	CHIP C 680PF K	
C2 -6			CK73FB1C104K	CHIP C 0.10UF K	



indicated safety critical components.

PARTS LIST

* New Parts

Parts without **Parts No.** are not supplied.

Les articles non mentionnés dans le **Parts No.** ne sont pas fournis.

Teile ohne **Parts No.** werden nicht geliefert.

SWITCH UNIT (X13-9720-10)

Ref. No.	A d d	N e w	Parts No.	Description	Desti nati on
C7 C13 -16			CK73EB1C225K CK73FB1H103K	CHIP C 2.2UF K CHIP C 0.010UF K	
304 CN1	2C		E29-1596-04 E59-0833-05	CONDUCTIVE RUBBER RECTANGULAR PLUG	
CP1 R1 R2 -5 R6 R8			R90-1016-05 RK73FB2A433J RK73FB2A222J RK73FB2A102J RK73FB2A223J	MULTI-COMP 470 X4 CHIP R 43K J 1/10W CHIP R 2.2K J 1/10W CHIP R 1.0K J 1/10W CHIP R 22K J 1/10W	
R9 R10 R16 R17 R18 -22			RK73FB2A101J RK73FB2A222J RK73EB2B331J RK73EB2B391J RK73EB2B331J	CHIP R 100 J 1/10W CHIP R 2.2K J 1/10W CHIP R 330 J 1/8W CHIP R 390 J 1/8W CHIP R 330 J 1/8W	
R23 ,24 R25 R26 R27 R28			RK73FB2A103J RK73EB2B331J RK73EB2B102J RK73FB2A751J RK73EB2B102J	CHIP R 10K J 1/10W CHIP R 330 J 1/8W CHIP R 1.0K J 1/8W CHIP R 750 J 1/10W CHIP R 1.0K J 1/8W	
R29			RK73FB2A102J	CHIP R 1.0K J 1/10W	
S1 -13 S14 -17 S18 -20 S21 S22			S70-0856-05 S70-0860-05 S70-0851-05 S70-0857-05 S68-0822-05	TACT SWITCH TACT SWITCH TACT SWITCH TACT SWITCH PUSH SWITCH	
S23			S70-0864-05	TACT SWITCH	
D1 IC1 IC3 Q1 ,2 Q1 ,2			MA3091-M LC75808W RS-171 DTA114EK UN2111	ZENER DIODE MOS-IC ANALOGUE IC DIGITAL TRANSISTOR DIGITAL TRANSISTOR	
Q3 ,4 Q5 Q5 Q5 Q6			2SD2114K DTC114YK KRC107S UN2214 DTB123YK	TRANSISTOR DIGITAL TRANSISTOR TRANSISTOR DIGITAL TRANSISTOR DIGITAL TRANSISTOR	
Q7 Q7 Q7 Q8 Q8			DTC114YK KRC107S UN2214 2SC2412K 2SD601A	DIGITAL TRANSISTOR TRANSISTOR DIGITAL TRANSISTOR TRANSISTOR TRANSISTOR	
SUB CIRCUIT UNIT (X13-9780-10)					
310	1C	*	B03-3056-12	DRESSING PLATE	
J1	2C		E58-0895-05	RECTANGULAR RECEPTACLE	
FPC1	2D		J84-0106-02	FLEXIBLE PRINTED WIRING BOARD	
Y	2C		N38-2025-46	PAN HEAD MACHIN SCREW	
ELECTRIC UNIT (X25-8470-13)					
C1			C90-5242-05	ELECTRO 3300UF 16WV	
C2			CK73FB1H103K	CHIP C 0.010UF K	
C3			C90-2926-05	ELECTRO 220UF 16WV	

Ref. No.	A d d	N e w	Parts No.	Description	Desti nati on
C4 C5 C6 C7 C8			CK73FB1H103K C90-2594-05 CE04CW0J101M CK73EB1C105K CE04CW1A221M	CHIP C 0.010UF K ELECTRO 10UF 10WV ELECTRO 100UF 6.3WV CHIP C 1.0UF K ELECTRO 220UF 10WV	
C10 C13 C14 C15 C16 ,17			CE04CW1A101M CK73FB1H223K C90-2608-05 C90-2595-05 CK73EB1C225K	ELECTRO 100UF 10WV CHIP C 0.022UF K ELECTRO 1.0UF 50WV ELECTRO 4.7UF 16WV CHIP C 2.2UF K	
C18 C19 ,20 C21 C22 C23			C90-2962-05 CK73EB1C225K CE04CW1C220M CK73GB1E223K CK73FB1H103K	ELECTRO 100UF 16WV CHIP C 2.2UF K ELECTRO 22UF 16WV CHIP C 0.022UF K CHIP C 0.010UF K	
C24 C25 ,26 C27 C28 C29			C90-2595-05 CK73FB1E473K C90-2598-05 CK73FB1E683K C90-2602-05	ELECTRO 4.7UF 16WV CHIP C 0.047UF K ELECTRO 3.3UF 25WV CHIP C 0.068UF K ELECTRO 0.10UF 50WV	
C30 C31 ,32 C33 C34 C35			CK73FB1H102K CK73FB1H103K CE04CW0J470M CK73FB1H103K CC73FCH1H240J	CHIP C 1000PF K CHIP C 0.010UF K ELECTRO 47UF 6.3WV CHIP C 0.010UF K CHIP C 24PF J	
C36 C37 C38 C48 ,49 C50			CC73FCH1H270J CK73EB1C105K CK73FB1H472K C90-2597-05 CK73FB1C104K	CHIP C 27PF J CHIP C 1.0UF K CHIP C 4700PF K ELECTRO 10UF 16WV CHIP C 0.10UF K	
C51 C52 ,53 C54 C55 C56			CK73FB1H103K C90-2597-05 CC73FCH1H121J CK73FB1C823K CK73FB1C104K	CHIP C 0.010UF K ELECTRO 10UF 16WV CHIP C 120PF J CHIP C 0.082UF K CHIP C 0.10UF K	
C57 C58 C59 C60 C61			CK73EB1C474K CK73GB1E183K CK73FB1H103K CE04CW1A101M C90-2610-05	CHIP C 0.47UF K CHIP C 0.018UF K CHIP C 0.010UF K ELECTRO 100UF 10WV ELECTRO 2.2UF 50WV	
C62 C63 C64 C65 ,66 C69 -76			CK73FB1H103K C93-1054-05 C90-2608-05 C90-2610-05 CK73FB1C274K	CHIP C 0.010UF K CHIP C 0.012UF K ELECTRO 1.0UF 50WV ELECTRO 2.2UF 50WV CHIP C 0.27UF K	
C77 -80 C81 ,82 C85 ,86 C89 -92 C95 -98			CK73FB1C104K CE04CW1C220M CE04CW1C220M C90-2597-05 C90-5296-05	CHIP C 0.10UF K ELECTRO 22UF 16WV ELECTRO 22UF 16WV ELECTRO 10UF 16WV ELECTRO 0.22UF 50WV	
C99 C100 C101 C102 C111			C90-2935-05 C90-2608-05 CE04CW1A101M C90-2608-05 CE04CW0J470M	ELECTRO 1.0UF 50WV ELECTRO 1.0UF 50WV ELECTRO 100UF 10WV ELECTRO 1.0UF 50WV ELECTRO 47UF 6.3WV	

PARTS LIST

* New Parts

Parts without **Parts No.** are not supplied.

Les articles non mentionnes dans le **Parts No.** ne sont pas fournis.

Teile ohne **Parts No.** werden nicht geliefert.

ELECTRIC UNIT (X25-8470-13)

Ref. No.	A d d	N e w	Parts No.	Description	Desti nati on
C112,113			C90-2606-05	ELECTRO 0.47UF 50WV	
C115,116			CK73FB1C224K	CHIP C 0.22UF K	
C117			C90-2594-05	ELECTRO 10UF 10WV	
C118			CK73FB1H103K	CHIP C 0.010UF K	
C119			C90-2594-05	ELECTRO 10UF 10WV	
C120,121			CC73FCH1H100D	CHIP C 10PF D	
C122			CC73FCH1H271J	CHIP C 270PF J	
C123-126			CC73FSL1H102J	CHIP C 1000PF J	
C144			CK73FB1H103K	CHIP C 0.010UF K	
C146			CK73FB1H103K	CHIP C 0.010UF K	
C147			CE04CW1A101M	ELECTRO 100UF 10WV	
C148			CK73FB1E273K	CHIP C 0.027UF K	
C151			CK73FB1H103K	CHIP C 0.010UF K	
C153			CK73FB1H103K	CHIP C 0.010UF K	
C159			CK73FB1H103K	CHIP C 0.010UF K	
C160			CK73EB1C225K	CHIP C 2.2UF K	
C162,163			CK73FB1H103K	CHIP C 0.010UF K	
CN1			E40-3241-05	PIN ASSY	
CN2			E40-3299-05	PIN ASSY	
CN3			E40-3252-05	PIN ASSY	
CN4			E40-3261-05	PIN ASSY	
CN5			E40-9550-05	FLAT CABLE CONNECTOR	
CN6			E40-9557-05	FLAT CABLE CONNECTOR	
CN7			E40-5029-05	FLAT CABLE CONNECTOR	
J1			E58-0836-05	RECTANGULAR RECEPTACLE	
WH1	2D		E30-4440-05	CORD WITH PLUG	
WH1	2D		E30-4804-05	CORD WITH PLUG	
L1			L40-4795-34	SMALL FIXED INDUCTOR	
L2			L40-2205-34	SMALL FIXED INDUCTOR(22UH)	
L3 -7			L40-4795-34	SMALL FIXED INDUCTOR	
L8			L33-1039-05	LINE FILTER COIL	
L9			L39-1004-05	TRAP COIL	
L10			L40-4795-34	SMALL FIXED INDUCTOR	
L11			L92-0075-05	CHIP FERRITE	
X1			L78-0683-05	RESONATOR	
X2			L77-2738-05	CRYSTAL RESONATOR	
X3			L77-2002-05	CRYSTAL RESONATOR	
S	3D		N83-3005-46	PAN HEAD TAPTITE SCREW	
T	2D		N35-3010-46	BINDING HEAD MACHINE SCREW	
W	3D		N86-2606-46	BINDING HEAD TAPTITE SCREW	
X	2D		N83-3012-46	PAN HEAD TAPTITE SCREW	
CP2			R90-0724-05	MULTI-COMP 1K X4	
CP3			R90-1022-05	MULTI-COMP 470 X2	
CP4 -7			R90-0725-05	MULTI-COMP 1K X2	
CP9			R90-0725-05	MULTI-COMP 1K X2	
R1			RK73FB2A223J	CHIP R 22K J 1/10W	
R2			RK73FB2A101J	CHIP R 100 J 1/10W	
R3			RK73FB2A223J	CHIP R 22K J 1/10W	
R4			RK73FB2A222J	CHIP R 2.2K J 1/10W	
R5			RK73EB2B221J	CHIP R 220 J 1/8W	
R6			RK73FB2A153J	CHIP R 15K J 1/10W	
R7			R92-3032-05	CHIP R 4.3K D 1/10W	
R8 ,9			R92-3052-05	METAL GLAZE RESISTOR	
R11			RK73FB2A152J	CHIP R 1.5K J 1/10W	

Ref. No.	A d d	N e w	Parts No.	Description	Desti nati on
R12			RK73FB2A751J	CHIP R 750 J 1/10W	
R13			RK73FB2A471J	CHIP R 470 J 1/10W	
R14			RK73GB1J104J	CHIP R 100K J 1/16W	
R16			RK73EB2B103J	CHIP R 10K J 1/8W	
R20			RK73EB2B104J	CHIP R 100K J 1/8W	
R21			RK73FB2A102J	CHIP R 1.0K J 1/10W	
R22			RK73FB2A104J	CHIP R 100K J 1/10W	
R23			RK73FB2A750J	CHIP R 75 J 1/10W	
R24			RK73FB2A272J	CHIP R 2.7K J 1/10W	
R25			RK73FB2A470J	CHIP R 47 J 1/10W	
R26			RK73EB2B102J	CHIP R 1.0K J 1/8W	
R27			RK73GB1J752J	CHIP R 7.5K J 1/16W	
R28			RK73GB1J563J	CHIP R 56K J 1/16W	
R29			RK73GB1J913J	CHIP R 91K J 1/16W	
R30			RK73FB2A470J	CHIP R 47 J 1/10W	
R31			RK73FB2A103J	CHIP R 10K J 1/10W	
R32			RK73GB1J913J	CHIP R 91K J 1/16W	
R33			RK73FB2A913J	CHIP R 91K J 1/10W	
R34			RK73FB2A472J	CHIP R 4.7K J 1/10W	
R35			R92-0366-05	CHIP R 560 J 1W	
R36			RK73FB2A223J	CHIP R 22K J 1/10W	
R37			RK73FB2A472J	CHIP R 4.7K J 1/10W	
R38			R92-0365-05	CHIP R 1.0K J 1/2W	
R39			RK73FB2A223J	CHIP R 22K J 1/10W	
R40			R92-0365-05	CHIP R 1.0K J 1/2W	
R41			RK73EB2B472J	CHIP R 4.7K J 1/8W	
R42			RK73EB2B222J	CHIP R 2.2K J 1/8W	
R43 -45			RK73EB2B470J	CHIP R 47 J 1/8W	
R46			RK73EB2B222J	CHIP R 2.2K J 1/8W	
R47 ,48			RK73EB2B472J	CHIP R 4.7K J 1/8W	
R50 ,51			RK73FB2A123J	CHIP R 12K J 1/10W	
R52			RK73FB2A562J	CHIP R 5.6K J 1/10W	
R53			RK73GB1J223J	CHIP R 22K J 1/16W	
R54			RD14DB2H332J	SMALL-RD 3.3K J 1/2W	
R56 ,57			RK73EB2B104J	CHIP R 100K J 1/8W	
R58			RK73FB2A183J	CHIP R 18K J 1/10W	
R59			RK73GB1J104J	CHIP R 100K J 1/16W	
R61			RK73FB2A104J	CHIP R 100K J 1/10W	
R63			RK73FB2A104J	CHIP R 100K J 1/10W	
R65			RK73FB2A104J	CHIP R 100K J 1/10W	
R66			RK73FB2A222J	CHIP R 2.2K J 1/10W	
R67			RK73GB1J472J	CHIP R 4.7K J 1/16W	
R68			RK73FB2A225J	CHIP R 2.2M J 1/10W	
R69			RK73FB2A222J	CHIP R 2.2K J 1/10W	
R70			RK73FB2A102J	CHIP R 1.0K J 1/10W	
R71			RK73GB1J472J	CHIP R 4.7K J 1/16W	
R72 ,73			RK73FB2A562J	CHIP R 5.6K J 1/10W	
R74			RK73FB2A223J	CHIP R 22K J 1/10W	
R76			RK73GB1J470J	CHIP R 47 J 1/16W	
R77			RK73FB2A104J	CHIP R 100K J 1/10W	
R78			RK73FB2A470J	CHIP R 47 J 1/10W	
R79 ,80			RK73FB2A222J	CHIP R 2.2K J 1/10W	
R83			RK73GB1J104J	CHIP R 100K J 1/16W	
R84			RK73FB2A102J	CHIP R 1.0K J 1/10W	
R86			RK73FB2A561J	CHIP R 560 J 1/10W	



indicated safety critical components.

PARTS LIST

* New Parts

Parts without **Parts No.** are not supplied.

Les articles non mentionnés dans le **Parts No.** ne sont pas fournis.

Teile ohne **Parts No.** werden nicht geliefert.

ELECTRIC UNIT (X25-8470-13)

Ref. No.	A d d	N e w	Parts No.	Description	Desti nati on
R89			RK73FB2A104J	CHIP R 100K J 1/10W	
R90			RK73GB1J222J	CHIP R 2.2K J 1/16W	
R92			RK73GB1J102J	CHIP R 1.0K J 1/16W	
R94			RK73GB1J223J	CHIP R 22K J 1/16W	
R95 ,96			RK73GB1J472J	CHIP R 4.7K J 1/16W	
R99			RK73GB1J102J	CHIP R 1.0K J 1/16W	
R100			RK73FB2A102J	CHIP R 1.0K J 1/10W	
R101			RK73GB1J104J	CHIP R 100K J 1/16W	
R102,103			RK73FB2A470J	CHIP R 47 J 1/10W	
R104			RK73FB2A104J	CHIP R 100K J 1/10W	
R105-107			RK73FB2A222J	CHIP R 2.2K J 1/10W	
R108			RK73GB1J222J	CHIP R 2.2K J 1/16W	
R112,113			RK73GB1J222J	CHIP R 2.2K J 1/16W	
R114			RK73GB1J164J	CHIP R 160K J 1/16W	
R116			RK73GB1J102J	CHIP R 1.0K J 1/16W	
R117			RK73FB2A102J	CHIP R 1.0K J 1/10W	
R118			RK73GB1J102J	CHIP R 1.0K J 1/16W	
R119			RK73EB2B102J	CHIP R 1.0K J 1/8W	
R130			RK73FB2A473J	CHIP R 47K J 1/10W	
R131			RK73FB2A472J	CHIP R 4.7K J 1/10W	
R132-136			RK73EB2B471J	CHIP R 470 J 1/8W	
R137-139			RK73FB2A222J	CHIP R 2.2K J 1/10W	
R140			RK73EB2B472J	CHIP R 4.7K J 1/8W	
R141,142			RK73GB1J104J	CHIP R 100K J 1/16W	
R143,144			RK73FB2A104J	CHIP R 100K J 1/10W	
R145			RK73FB2A472J	CHIP R 4.7K J 1/10W	
R147			RK73FB2A472J	CHIP R 4.7K J 1/10W	
R153,154			RK73EB2B361J	CHIP R 360 J 1/8W	
R155,156			RK73FB2A472J	CHIP R 4.7K J 1/10W	
R157,158			RK73FB2A222J	CHIP R 2.2K J 1/10W	
R159,160			RK73EB2B361J	CHIP R 360 J 1/8W	
R161,162			RK73FB2A472J	CHIP R 4.7K J 1/10W	
R163,164			RK73FB2A222J	CHIP R 2.2K J 1/10W	
R167,168			RK73FB2A103J	CHIP R 10K J 1/10W	
R169,170			RK73FB2A223J	CHIP R 22K J 1/10W	
R171,172			RK73FB2A820J	CHIP R 82 J 1/10W	
R174			RK73EB2B102J	CHIP R 1.0K J 1/8W	
R175,176			RK73FB2A103J	CHIP R 10K J 1/10W	
R177,178			RK73FB2A223J	CHIP R 22K J 1/10W	
R179,180			RK73FB2A820J	CHIP R 82 J 1/10W	
R181-184			RK73FB2A472J	CHIP R 4.7K J 1/10W	
R185			RK73GB1J184J	CHIP R 180K J 1/16W	
R186			RK73FB2A431J	CHIP R 430 J 1/10W	
R187			RK73FB2A751J	CHIP R 750 J 1/10W	
R188			RK73FB2A243J	CHIP R 24K J 1/10W	
R189			RK73FB2A102J	CHIP R 1.0K J 1/10W	
R190			RK73FB2A101J	CHIP R 100 J 1/10W	
R191			RK73FB2A223J	CHIP R 22K J 1/10W	
R192			RK73GB1J333J	CHIP R 33K J 1/16W	
R193,194			RK73EB2B100J	CHIP R 10 J 1/8W	
R195			RK73EB2B4R7J	CHIP R 4.7 J 1/8W	
R196			RK73EB2B104J	CHIP R 100K J 1/8W	
R197			RK73FB2A105J	CHIP R 1.0M J 1/10W	
R199			RK73GB1J104J	CHIP R 100K J 1/16W	
R200			RK73EB2B222J	CHIP R 2.2K J 1/8W	

Ref. No.	A d d	N e w	Parts No.	Description	Desti nati on
R232			RK73FB2A272J	CHIP R 2.7K J 1/10W	
R233			RK73FB2A223J	CHIP R 22K J 1/10W	
R234			RK73EB2B102J	CHIP R 1.0K J 1/8W	
R235			RK73FB2A223J	CHIP R 22K J 1/10W	
R236			RK73EB2B102J	CHIP R 1.0K J 1/8W	
R241			RK73FB2A101J	CHIP R 100 J 1/10W	
R242			RK73GB1J101J	CHIP R 100 J 1/16W	
R243,244			RK73FB2A102J	CHIP R 1.0K J 1/10W	
R247			RK73GB1J102J	CHIP R 1.0K J 1/16W	
R248			RK73FB2A104J	CHIP R 100K J 1/10W	
W16 ,17			R92-2052-05	CHIP R 0 J 1/10W	
W20 ,21			R92-2052-05	CHIP R 0 J 1/10W	
W28			R92-2052-05	CHIP R 0 J 1/10W	
PH1			T95-0231-05	OPTO ISOLATOR	
D1			RM10ZLF	DIODE	
D2			AM01Z	DIODE	
D2			ERA15-01	DIODE	
D3			MA4056(N)-M	ZENER DIODE	
D4			MA4082(N)-L	ZENER DIODE	
D5			MA4110-L	ZENER DIODE	
D7			MA4110(N)-M	ZENER DIODE	
D8			MA4056(N)-M	ZENER DIODE	
D11 ,12			AM01Z	DIODE	
D11 ,12			ERA15-01	DIODE	
D13			DAP202K	DIODE	
D13			KDS181	DIODE	
D13			MA152WA	DIODE	
D16			MA3062WA	ZENER DIODE	
D18			MA3062WA	ZENER DIODE	
D19			MA4056(N)-M	ZENER DIODE	
D20			MA4062(N)-M	ZENER DIODE	
D21			DAN202K	DIODE	
D21			KDS184	DIODE	
D21			MA152WK	DIODE	
D23 ,24			RD6.8M(B2)	ZENER DIODE	
D27			DAP202K	DIODE	
D27			KDS181	DIODE	
D27			MA152WA	DIODE	
D28 ,29			RD6.8MW	ZENER DIODE	
D32			MA3056-M	ZENER DIODE	
D33			SA-C2012-101TB	SURGE ABSORBER	
D34			DAN202K	DIODE	
D34			KDS184	DIODE	
D34			MA152WK	DIODE	
D35 -43			1SR154-400	DIODE	
D47 ,48			DAP202K	DIODE	
D47 ,48			KDS181	DIODE	
D47 ,48			MA152WA	DIODE	
D53 -59			DA204K	DIODE	
D53 -59			KDS226	DIODE	
D60			MA3062WA	ZENER DIODE	
IC1			UPD784217GC105M	MI-COM IC	
IC2			TDA7400	ANALOGUE IC	
IC3			M5237ML	IC(VOLTAGE REGULATOR)	

PARTS LIST

* New Parts

Parts without **Parts No.** are not supplied.

Les articles non mentionnés dans le **Parts No.** ne sont pas fournis.

Teile ohne **Parts No.** werden nicht geliefert.

Ref. No.	A d d	N e w	Parts No.	Description	Desti nati on
IC4			TDA7386	ANALOGUE IC	
IC5			TDA7401	ANALOGUE IC	
IC6			ICL7660SIBA	ANALOGUE IC	
IC7 ,8			NJM4565M-TE2	ANALOGUE IC	
IC10			TC74HC02AF	IC	
IC11			TDA7479D	ANALOGUE IC	
IC13			LB1930M	ANALOGUE IC	
IC14			BR24C01AF	MEMORY IC	
IC14			M24C01-WMN6T	MEMORY IC	
IC15			S-80830ANNP	MOS-IC	
Q1			2SB1565(E,F)	TRANSISTOR	
Q2			2SC2412K	TRANSISTOR	
Q2			2SD601A	TRANSISTOR	
Q3			2SB709A	TRANSISTOR	
Q4			2SB1565(E,F)	TRANSISTOR	
Q5			DTA124EK	DIGITAL TRANSISTOR	
Q5			KRA103S	TRANSISTOR	
Q5			UN2112	DIGITAL TRANSISTOR	
Q6			DTC124EK	DIGITAL TRANSISTOR	
Q6			KRC103S	TRANSISTOR	
Q6			UN2212	DIGITAL TRANSISTOR	
Q7			2SD2396F40	TRANSISTOR	
Q8			DTA124EK	DIGITAL TRANSISTOR	
Q8			KRA103S	TRANSISTOR	
Q8			UN2112	DIGITAL TRANSISTOR	
Q9			DTC124EK	DIGITAL TRANSISTOR	
Q9			KRC103S	TRANSISTOR	
Q9			UN2212	DIGITAL TRANSISTOR	
Q10			2SD1760	TRANSISTOR	
Q11			DTA123JK	DIGITAL TRANSISTOR	
Q12			DTC144EK	DIGITAL TRANSISTOR	
Q12			KRC104S	TRANSISTOR	
Q12			UN2213	DIGITAL TRANSISTOR	
Q13			2SB1443	TRANSISTOR	
Q14			2SC2412K	TRANSISTOR	
Q14			2SD601A	TRANSISTOR	
Q15			2SB709A	TRANSISTOR	
Q16			2SC2412K	TRANSISTOR	
Q16			2SD601A	TRANSISTOR	
Q17			2SB709A	TRANSISTOR	
Q18			2SC2412K	TRANSISTOR	
Q18			2SD601A	TRANSISTOR	
Q19			2SB709A	TRANSISTOR	
Q20			2SC2412K	TRANSISTOR	
Q20			2SD601A	TRANSISTOR	
Q21			2SB1277(Q,R)	TRANSISTOR	
Q22			DTC114EK	DIGITAL TRANSISTOR	
Q22			UN2211	DIGITAL TRANSISTOR	
Q23			2SB1277(Q,R)	TRANSISTOR	
Q24			2SB709A	TRANSISTOR	
Q25			DTA124EK	DIGITAL TRANSISTOR	
Q25			KRA103S	TRANSISTOR	
Q25			UN2112	DIGITAL TRANSISTOR	
Q26			DTC114EK	DIGITAL TRANSISTOR	
Q26			UN2211	DIGITAL TRANSISTOR	

ELECTRIC UNIT (X25-8470-13)

Ref. No.	A d d	N e w	Parts No.	Description	Desti nati on
Q28 ,29			2SC2412K	TRANSISTOR	
Q28 ,29			2SD601A	TRANSISTOR	
Q30 ,31			DTA124EK	DIGITAL TRANSISTOR	
Q30 ,31			KRA103S	TRANSISTOR	
Q30 ,31			UN2112	DIGITAL TRANSISTOR	
Q33			DTC124EK	DIGITAL TRANSISTOR	
Q33			KRC103S	TRANSISTOR	
Q33			UN2212	DIGITAL TRANSISTOR	
Q34 -37			2SC2412K	TRANSISTOR	
Q34 -37			2SD601A	TRANSISTOR	
Q38			DTC114YK	DIGITAL TRANSISTOR	
Q38			KRC107S	TRANSISTOR	
Q38			UN2214	DIGITAL TRANSISTOR	
Q41			2SB709A	TRANSISTOR	
Q48			2SB1188(Q,R)	TRANSISTOR	
Q49			DTC124EK	DIGITAL TRANSISTOR	
Q49			KRC103S	TRANSISTOR	
Q49			UN2212	DIGITAL TRANSISTOR	
Q50			2SB1188(Q,R)	TRANSISTOR	
Q51			DTC124EK	DIGITAL TRANSISTOR	
Q51			KRC103S	TRANSISTOR	
Q51			UN2212	DIGITAL TRANSISTOR	
Q52			DTC144EK	DIGITAL TRANSISTOR	
Q52			KRC104S	TRANSISTOR	
Q52			UN2213	DIGITAL TRANSISTOR	
Q53			DTA124EK	DIGITAL TRANSISTOR	
Q53			KRA103S	TRANSISTOR	
Q53			UN2112	DIGITAL TRANSISTOR	
TH1			PTH9C42BD471Q	POSITIVE RESISTOR	
A1	3D		X86-3100-10	TUNER UNIT	
CD PLAYER UNIT (X32-4740-00)					
C1 ,2			CK73FB1A105K	CHIP C 1.0UF K	
C3			C92-1359-05	CHIP-TAN 10UF 16WV	
C4			C92-0566-05	CHIP-TAN 10UF 6.3WV	
C5			CC73FCH1H330J	CHIP C 33PF J	
C6			CC73FCH1H030C	CHIP C 3.0PF C	
C7			CK73FB1C104K	CHIP C 0.10UF K	
C8			CK73FB1A105K	CHIP C 1.0UF K	
C9			CC73FCH1H101J	CHIP C 100PF J	
C10			CK73FB1H472K	CHIP C 4700PF K	
C11			CK73FB1H682K	CHIP C 6800PF K	
C12			CK73FB1H222K	CHIP C 2200PF K	
C13			CK73FB1H273K	CHIP C 0.027UF K	
C14			CK73FB1H472K	CHIP C 4700PF K	
C15			CK73FB1E473K	CHIP C 0.047UF K	
C16			CC73FCH1H101J	CHIP C 100PF J	
C17			CK73FB1H472K	CHIP C 4700PF K	
C18			CK73FB1H471K	CHIP C 470PF K	
C19 ,20			CK73FB1C104K	CHIP C 0.10UF K	
C21			C92-1359-05	CHIP-TAN 10UF 16WV	
C22			CK73FB1C104K	CHIP C 0.10UF K	
C23			CK73FB1H102K	CHIP C 1000PF K	
C24			CK73FB1H223K	CHIP C 0.022UF K	
C25			CK73FB1H123K	CHIP C 0.012UF K	



indicated safety critical components.

PARTS LIST

* New Parts

Parts without **Parts No.** are not supplied.

Les articles non mentionnés dans le **Parts No.** ne sont pas fournis.

Teile ohne **Parts No.** werden nicht geliefert.

CD PLAYER UNIT (X32-4740-00)

Ref. No.	A d d	N e w	Parts No.	Description	Desti nati on
C26			CK73FB1A105K	CHIP C 1.0UF K	
C28			CK73FB1A105K	CHIP C 1.0UF K	
C29			CK73FB1C104K	CHIP C 0.10UF K	
C31 ,32			CK73FB1H103K	CHIP C 0.010UF K	
C33 -36			CK73FB1C104K	CHIP C 0.10UF K	
C37			C93-1031-05	CERAMIC 0.010UF 50WV	
C40			CK73FB1C104K	CHIP C 0.10UF K	
C41			CK73EB1C225K	CHIP C 2.2UF K	
C43			CK73FB1H123K	CHIP C 0.012UF K	
C44			CK73FB1C104K	CHIP C 0.10UF K	
C45			CK73FB1H123K	CHIP C 0.012UF K	
C46			CK73FB1E473K	CHIP C 0.047UF K	
C51			C92-1324-05	CHIP-TAN 4.7UF 16WV	
C52			CK73FB1E473K	CHIP C 0.047UF K	
C53 ,54			C93-1084-05	CERAMIC 1200PF J	
C55			CK73FB1C104K	CHIP C 0.10UF K	
C61			CK73EB1C105K	CHIP C 1.0UF K	
C63			C92-1324-05	CHIP-TAN 4.7UF 16WV	
C65 ,66			CK73FB1A105K	CHIP C 1.0UF K	
C67 ,68			C92-1324-05	CHIP-TAN 4.7UF 16WV	
C71 -74			C93-1084-05	CERAMIC 1200PF J	
C75 -78			CC73FCH1H271J	CHIP C 270PF J	
C79 ,80			C93-1044-05	CERAMIC 2200PF K	
C81			CK73FB1H102K	CHIP C 1000PF K	
C83 ,84			CC73FCH1H100D	CHIP C 10PF D	
C85 -87			CK73FB1C104K	CHIP C 0.10UF K	
CN1			E40-9536-05	FLAT CABLE CONNECTOR	
CN2			E40-9339-05	FLAT CABLE CONNECTOR	
CP8			L92-0320-05	FERRITE CORE	
L1			L40-1001-78	SMALL FIXED INDUCTOR(10UH)	
L2			L92-0308-05	FERRITE CORE	
L3			L92-0334-05	CHIP FERRITE	
L14			L79-0938-05	LC FILTER	
L15			L92-0308-05	FERRITE CORE	
X1			L77-2081-05	CRYSTAL RESONATOR	
CP1 -3			R90-1019-05	MULTI-COMP 100 X2	
R1 ,2			RK73FB2A333J	CHIP R 33K J 1/10W	
R3			RK73FB2A823J	CHIP R 82K J 1/10W	
R5			RK73FB2A910J	CHIP R 91 J 1/10W	
R6			RK73FB2A823J	CHIP R 82K J 1/10W	
R8			RK73EB2B4R7J	CHIP R 4.7 J 1/8W	
R9			RK73EB2B100J	CHIP R 10 J 1/8W	
R10 ,11			RK73FB2A682J	CHIP R 6.8K J 1/10W	
R12			RK73FB2A432J	CHIP R 4.3K J 1/10W	
R13			RK73FB2A363J	CHIP R 36K J 1/10W	
R14 ,15			RK73FB2A824J	CHIP R 820K J 1/10W	
R16			RK73FB2A223J	CHIP R 22K J 1/10W	
R17			RK73FB2A363J	CHIP R 36K J 1/10W	
R18			RK73FB2A392J	CHIP R 3.9K J 1/10W	
R19			RK73FB2A273J	CHIP R 27K J 1/10W	
R20			RK73FB2A104J	CHIP R 100K J 1/10W	
R21			RK73FB2A224J	CHIP R 220K J 1/10W	
R22 ,23			RK73FB2A333J	CHIP R 33K J 1/10W	

Ref. No.	A d d	N e w	Parts No.	Description	Desti nati on
R31			RK73FB2A102J	CHIP R 1.0K J 1/10W	
R32			RK73FB2A104J	CHIP R 100K J 1/10W	
R34			RK73FB2A683J	CHIP R 68K J 1/10W	
R35			RK73FB2A104J	CHIP R 100K J 1/10W	
R36			RK73FB2A151J	CHIP R 150 J 1/10W	
R37			RK73FB2A471J	CHIP R 470 J 1/10W	
R38			RK73FB2A224J	CHIP R 220K J 1/10W	
R44			RK73FB2A512J	CHIP R 5.1K J 1/10W	
R45			RK73FB2A103J	CHIP R 10K J 1/10W	
R46			RK73FB2A102J	CHIP R 1.0K J 1/10W	
R47			RK73FB2A103J	CHIP R 10K J 1/10W	
R49			RK73FB2A472J	CHIP R 4.7K J 1/10W	
R50			RK73FB2A102J	CHIP R 1.0K J 1/10W	
R52			RK73FB2A104J	CHIP R 100K J 1/10W	
R54			RK73FB2A104J	CHIP R 100K J 1/10W	
R71			RK73FB2A103J	CHIP R 10K J 1/10W	
R72			RK73FB2A102J	CHIP R 1.0K J 1/10W	
R73			RK73FB2A473J	CHIP R 47K J 1/10W	
R74			RK73FB2A103J	CHIP R 10K J 1/10W	
R75			RK73FB2A333J	CHIP R 33K J 1/10W	
R76			RK73FB2A622J	CHIP R 6.2K J 1/10W	
R77			RK73FB2A563J	CHIP R 56K J 1/10W	
R78			RK73FB2A243J	CHIP R 24K J 1/10W	
R79			RK73FB2A242J	CHIP R 2.4K J 1/10W	
R80			RK73FB2A202J	CHIP R 2.0K J 1/10W	
R81			RK73FB2A333J	CHIP R 33K J 1/10W	
R82			RK73FB2A103J	CHIP R 10K J 1/10W	
R83			RK73FB2A102J	CHIP R 1.0K J 1/10W	
R91			RK73FB2A472J	CHIP R 4.7K J 1/10W	
R101,102			RK73FB2A241J	CHIP R 240 J 1/10W	
R103,104			RK73FB2A122J	CHIP R 1.2K J 1/10W	
R115-118			R92-2029-05	CHIP R 2.0K D 1/10W	
R119-122			R92-2044-05	CHIP R 2.7K D 1/10W	
R123-126			R92-2048-05	7.5K D 1/10W	
R127,128			RK73FB2A331J	CHIP R 330 J 1/10W	
R202			RK73FB2A102J	CHIP R 1.0K J 1/10W	
R210			RK73FB2A102J	CHIP R 1.0K J 1/10W	
R211			RK73FB2A681J	CHIP R 680 J 1/10W	
R215			RK73FB2A103J	CHIP R 10K J 1/10W	
R216,217			RK73FB2A155J	CHIP R 1.5M J 1/10W	
R218			RK73FB2A473J	CHIP R 47K J 1/10W	
R219			RK73FB2A472J	CHIP R 4.7K J 1/10W	
R220			RK73FB2A103J	CHIP R 10K J 1/10W	
W1			R92-2053-05	CHIP R 0 J 1/8W	
W3			R92-2052-05	CHIP R 0 J 1/10W	
W8			R92-2052-05	CHIP R 0 J 1/10W	
S1 ,2			S68-0838-05	PUSH SWITCH	
S3			S68-0823-05	PUSH SWITCH	
D1 ,2			DAN202U	DIODE	
D3			DA204K	DIODE	
D4			DAN202U	DIODE	
IC1			AN8806SB	ANALOGUE IC	
IC2			MN662773KB3	MOS-IC	

PARTS LIST

* New Parts

Parts without **Parts No.** are not supplied.

Les articles non mentionnes dans le **Parts No.** ne sont pas fournis.

Teile ohne **Parts No.** werden nicht geliefert.

CD PLAYER UNIT (X32-4740-00)

Ref. No.	A d d	N e w	Parts No.	Description	Desti nati on
IC4			BA5917AFP	ANALOGUE IC	
IC5			TA78L05F	IC(VOLTAGE REGULATOR/ +5V)	
IC6			NJM5532MD	IC(OP AMP)	
IC7			KKZ05F	CUSTOM IC	
IC8			TC7SH08F	MOS-IC	
IC9			TC7SZ04F	MOS-IC	
Q1			2SB1188	TRANSISTOR	
Q2			DTC124EUA	DIGITAL TRANSISTOR	
Q3 ,4			2SA1362(Y)	TRANSISTOR	
Q5			DTC124EUA	DIGITAL TRANSISTOR	
Q7			FMC5A	DIGITAL TRANSISTOR	
Q8			DTC124EUA	DIGITAL TRANSISTOR	
MECHANISM ASSY (X92-3710-00)					
401	2A		A10-4482-01	CHASSIS	
402	1B		A10-4225-33	CHASSIS CALKING ASSY	
403	2B		A11-0915-43	SUB CHASSIS CALKING ASSY	
405A	2A		D10-4038-23	ARM ASSY	
406	2A		D10-4306-04	ARM ASSY	
407	2A		D10-4305-04	ARM ASSY	
408	3A		D10-3087-44	ARM ASSY	
409	3B		D10-3092-03	SLIDER	
410	3B		D10-3093-04	SLIDER ASSY	
411	2B		D10-3095-04	SLIDER ASSY	
412	2B		D10-3096-04	SLIDER ASSY	
413	1A		D10-3099-24	SLIDER ASSY	
414	1A		D10-3100-04	SLIDER ASSY	
415	2A		D10-4123-24	LEVER ASSY	
416	1B		D10-4004-04	LEVER ASSY	
417	1B		D10-4006-04	LEVER	
418	1A		D10-4007-04	LEVER	
419	2B		D10-4008-14	LEVER	
420	2A		D10-4009-23	ARM	
421	3A		D10-4010-04	LEVER	
422	3A		D10-4011-34	LEVER ASSY	
423	3A		D10-4013-14	ARM ASSY	
424	3B		D10-4050-04	ARM	
427	3B		D13-1340-13	RACK (GEAR)	
429	3B		D13-1231-04	GEAR	
430	3A		D13-1232-04	GEAR	
431	3B		D13-1233-04	GEAR	
432	3B		D13-1234-14	GEAR ASSY	
433	3A		D13-1238-03	GEAR	
434	3B		D13-1240-04	GEAR	
435	3B		D13-1241-04	GEAR	
436	3A		D13-1242-04	GEAR	
437	1B		D13-1243-04	GEAR	
438	1B		D13-1244-04	GEAR	
439	1B		D13-1245-14	GEAR	
440	2A		D13-1246-04	GEAR	
441	2B		D13-1247-04	GEAR	
443	2B		D13-1249-04	GEAR ASSY	
445	1B		D14-0668-04	ROLLER	
446	2A		D14-0670-04	ROLLER	
447	3B		D14-0674-04	ROLLER	
448	2B		D13-1341-04	GEAR ASSY	

Ref. No.	A d d	N e w	Parts No.	Description	Desti nati on
499	3A		D21-2228-14	SHAFT	
450	1A		D21-2229-04	SHAFT	
451	1A		D23-0925-24	RETAINER	
452	2A		D32-0614-04	STOPPER	
453	1B		D39-0223-05	DAMPER	
454	2B		D39-0224-05	DAMPER	
455	3B		F09-1246-04	SHEET	
458	3B		F09-1266-14	SHEET	
460	2A		G01-2770-04	EXTENSION SPRING	
461	3A		G01-2771-04	EXTENSION SPRING	
462	3A		G01-2772-24	EXTENSION SPRING	
463	3A		G01-2773-14	EXTENSION SPRING	
464	3A		G01-2774-34	EXTENSION SPRING	
465	1B		G01-2775-04	TORSION COIL SPRING	
466	1B		G01-2776-14	TORSION COIL SPRING	
467	3B		G01-2777-24	TORSION COIL SPRING	
469	2A		G01-2844-04	EXTENSION SPRING	
470	2A		G02-1231-04	FLAT SPRING	
471	2B		G02-1232-24	FLAT SPRING	
472	2A		G02-1241-24	FLAT SPRING	
475	2A		J11-0613-13	CLAMPER	
476	3A		J19-4678-13	HOLDER	
477	2B		J19-4679-24	HOLDER	
478	3B		J21-7684-13	MOUNTING HARDWARE	
479	2B		J21-7686-13	MOUNTING HARDWARE	
480	1B		J21-7690-03	MOUNTING HARDWARE	
481	3A		J31-1032-04	COLLAR	
482	3A		J84-0107-05	FLEXIBLE PRINTED WIRING BOARD	
483	1A		J90-0757-22	GUIDE	
A	2A		N09-4249-05	MACHINE SCREW (M1.7X2.5,LOCK)	
B	1B		N09-4172-05	TAPPING SCREW (2X3.5)	
C	2B		N09-4202-05	STEPPED SCREW	
D	2A		N38-2020-46	PAN HEAD MACHIN SCREW	
E	3A		N09-4294-05	TAPPING SCREW	
F	3B		N19-2023-04	FLAT WASHER	
G	2A		N19-2058-04	FLAT WASHER	
H	3A		N19-2093-04	FLAT WASHER	
DM1	3B		T42-0764-04	DC MOTOR ASSY	
DM2	3B		T42-0763-04	DC MOTOR ASSY	
DPU1	2B		T25-0215-05	OPTICAL PICKUP HEAD	

KDC-X715

SPECIFICATIONS

FM

Frequency Range 87.9MHz~107.9MHz
Frequency Step 200kHz
Channel Space Selection 50k/200kHz
Usable Sensitivity (S/N : 30dB) 9.3dBf (0.8 μ /75 Ω)
Quieting Sensitivity (S/N : 50dB) 15.2dBf (1.6 μ V/75 Ω)
Frequency Response (\pm 3.0dB) 30Hz~15kHz
S/N 70dB (MONO)
Selectivity \geq 80dB (\pm 400kHz)
Stereo Separation 40dB (1kHz)

AM

Frequency Range 530kHz~1700kHz
Frequency Step 10kHz
Channel Space Selection 9k/10kHz
Usable Sensitivity (S/N : 20dB) 28dB μ (25 μ V)

CD

Laser Diode GaAlAs (λ =780nm)
Digital Filter (D/A) 8 Times Over Sampling
D/A Converter 1 Bit
Spindle Speed 500~200 (CLV)
Wow & Flutter Below Mesurable Limit

Frequency Response 10Hz~20kHz(\pm 1 dB)
Total Harmonic Distortion 0.01% (1kHz)
S/N Ratio (dB) 105dB (1kHz)
Dynamic Range 100dB
Channel Separation 95dB

AUDIO

Preout Level (mV)/Load 4500mV/10k Ω
Preout Impedance (Ω) 80 Ω
Max Power 45WX4
Full bandwidth (at less than 1% THD) 22WX4
Tone Action
Bass 100Hz \pm 10dB
Treble 10kHz \pm 10dB

GENERAL

Operating Voltage (11~16V allowable) 14.4V
Current Consumption 10A
Installation Size (WXHXD) 182X53X162mm
7-3/16X2-1/16X6-3/8in
Weight 4.2lbs(1.9kg)

KENWOOD follows policy of continuous advancements in development. For this reason specifications may be changed without notice.

KENWOOD CORPORATION

14-6, Dogenzaka 1-chome, Shibuya-ku, Tokyo, 150-8501 Japan

KENWOOD SERVICE CORPORATION

P.O. Box 22745, 2201 East Dominguez Street,
Long Beach, CA90801-5745, U.S.A.

KENWOOD ELECTRONICS CANADA INC.

6070 Kestrel Road, Mississauga, Ontario, Canada L5T 1S8

KENWOOD ELECTRONICS LATIN AMERICA S.A.

P.O. Box 55-2791, Piso 6, Plaza Chase, Cl. 47 y,
Aquilino de la Guardia, Panama, Republic of Panama

KENWOOD ELECTRONICS BRASIL LTDA.

Av. Moema, 170-17", Andar-Cobertura "B",
Ed. Maximum Service Center, 04077-020 Moema,
São Paulo-SP-Brasil

KENWOOD ELECTRONICS UK LIMITED

Kenwood House, Dwight Road, Watford,
Herts, WD1 8EB, United Kingdom

KENWOOD ELECTRONICS DEUTSCHLAND GMBH

Rembrücker-Str. 15, 63150 Heusenstamm, Germany

KENWOOD ELECTRONICS FRANCE S.A.

13, Boulevard Ney, 75018 Paris, France

KENWOOD ELECTRONICS BELGIUM N.V.

Mechelsesteenweg 418, B-1930 Zaventem, Belgium

KENWOOD ELECTRONICS ITALIA S.p.A.

Via G. Sirtori 7/9, 20129 Milano, Italy

KENWOOD IBÉRICA S.A.

Bolivia, 239-08020 Barcelona, Spain

KENWOOD ELECTRONICS AUSTRALIA PTY. LTD.

(A.C.N. 001 499 074)

16 Giffnock Avenue, North Ryde, N.S.W. 2113, Australia

KENWOOD ELECTRONICS (HONG KONG) LTD.

Unit 3712-3724, Level 37, Tower 1, Metroplaza,
223 Hing Fong Road, Kwai Fong, N.T., Hong Kong

KENWOOD ELECTRONICS GULF FZE

P.O. Box 61318, Jebel Ali, Dubai, U.A.E.

KENWOOD ELECTRONICS (THAILAND) CO., LTD.

2019 New Pechburi Road, Bangkapi, Huaykwang,
Bangkok, 10320 Thailand

KENWOOD ELECTRONICS SINGAPORE PTE. LTD.

1 Genting Lane, #07-00, Kenwood Building, Singapore 349544

KENWOOD ELECTRONICS (MALAYSIA) SDN BHD

#4.01 Level 4, Wisma Academy, Lot 4A, Jalan 19/1,
46300 Petaling Jaya, Selangor Darul Ehsan, Malaysia